

DIVISION V
SECTION 5600
STORM DRAINAGE SYSTEMS &
FACILITIES

(February 16, 2011)

DIVISION V
DESIGN CRITERIA
5600 STORM DRAINAGE SYSTEMS & FACILITIES
 APPROVED AND ADOPTED THIS 15 DAY OF DECEMBER 2010
 KANSAS CITY METROPOLITAN CHAPTER
 OF THE AMERICAN PUBLIC WORKS ASSOCIATION

TABLE OF CONTENTS

<u>Section</u>	<u>Page</u>
SECTION 5601 ADMINISTRATIVE.....	1
5601.1 Introduction	1
5601.2 Definitions	1
5601.3 General Requirements and Applicability	4
5601.4 Existing Drainage System	4
5601.5 System Types and Applications	4
5601.6 Waivers	7
5601.7 Other Requirements	7
5601.8 Levels of Service	7
SECTION 5602 HYDROLOGY	11
5602.1 Scope	11
5602.2 Computation Methods for Runoff	11
5602.3 Runoff Coefficients	15
5602.4 Rainfall Mass	17
5602.5 Unit Hydrographs	17
5602.6 Rainfall Intensity	17
5602.7 Time of Concentration and Lag Time	18
5602.8 Hydrograph Routing	22
5602.9 Calibration and Model Verification	22
SECTION 5603 HYDRAULICS.....	27
5603.1 Hydraulic Calculations for Pipes, Culverts, and Open Channels	27
5603.2 Analysis of Systems by Computer Models	31
SECTION 5604 INLETS, MANHOLES AND JUNCTION BOXES	47
5604.1 Inlet Design	47
5604.2 Gutter Flow	47
5604.3 Gutter Capacity	48
5604.4 Freeboard Requirements	48
5604.5 Inverts and Pipes	48
5604.6 Loading Conditions for Structures	48
5604.7 Street Grade on Vertical Curves	48
5604.8 Curb Inlet Intercept Equations	49
SECTION 5605 NATURAL STREAMS	62
5605.1 Scope	62
5605.2 Natural Stream Benefits and Characteristics:	62

5605.3	Stream Preservation and Buffers Zones	64
5605.4	In Stream Construction - General Requirements	65
5605.5	Stream Assessment	65
5605.6	Discharge Outfalls	72
5605.7	Culverts, Bridges, and Above Grade Crossings	72
5605.8	Below Grade Stream Crossings	73
5605.9	Grade Control	73
5605.10	Floodplain Fills:	75
5605.11	Flood Control Projects:	75
5605.12	Bank Stabilization Projects	75
5605.13	Stream Restoration	77
5605.14	Comprehensive Stream Management:	77
SECTION 5606 ENCLOSED PIPE SYSTEMS		81
5606.1	Easements	81
5606.2	Capacity	81
5606.3	Pressure Flow	82
5606.4	Energy Dissipation:	82
5606.5	Velocity within the System	84
5606.6	Loading	84
SECTION 5607 ENGINEERED CHANNELS		85
5607.1	Introduction	85
5607.2	Easements	85
5607.3	Freeboard	85
5607.4	Channel Linings	85
5607.5	Lining Material	85
5607.6	Side Slopes	90
5607.7	Alignment Changes	90
5607.8	Vertical Wall Channels	90
5607.9	Energy Management	90
SECTION 5608 STORMWATER DETENTION AND RETENTION		91
5608.1	Scope	91
5608.2	Access and Easements	91
5608.3	Maintenance and Continued Performance	91
5608.4	5608.4 Performance Criteria	91
5608.5	Detention Methods:	94
5608.6	Required Submittals:	96
5608.7	Additional Requirements	96
SECTION 5609 PLAN REQUIREMENTS		97
5609.1	Scope	97
5609.2	General	97
5609.3	Type of Sheets in Plans	97
5609.4	Sheet Sizes	97
5609.5	Scales	97
5609.6	Required Information for Title Sheet:	98
5609.7	Required Information for General Layout Sheet:	98
5609.8	Required Information for Plan and Profile Sheets:	99
5609.9	Cross-Section Sheets	99
5609.10	Drainage Area Map	100
5609.11	Standard and Special Detail Sheets	100
5609.12	Traffic Control Plans (if required)	100
5609.13	Temporary Erosion Control Plan Sheets	100

5609.14	Grading Plan Sheets (if required).....	100
5609.15	Property Line and Easement Sheets	100

SECTION 5610 REFERENCES.....101

APPENDIX A Microsoft Visual Basic Function for Inlet Interception Calculations

LIST OF FIGURES

<u>Figure</u>		<u>Page</u>
Figure 5601-1:	Guide to Stormwater Management for Site Developmet.....	10
Figure 5602-1:	Intensity-Duration-Frequency (IDF) Curves for Kansas City, Missouri.....	19
Figure 5602-2:	Overland Flow (Inlet) Time Nomograph	20
Figure 5602-3:	Channel Flow Time Nomograph	21
Figure 5602-4:	100-year Discharge per Kansas Rural Regression Formula (2000) and Gage Estimates	23
Figure 5602-5:	100-year Discharge per Missouri Rural Regression Formula and Gage Estimates.....	24
Figure 5602-6:	Documented Extreme Streamflows (no return period estimates) in Kansas City and the Region, as Discharges per Unit Drainage Area	25
Figure 5602-7:	Documented Extreme Streamflows (no return period estimated) in Kansas City and the Region, as Absolute Discharges	26
Figure 5603-1:	Headwater Depth for Box Culverts with Inlet Control.....	33
Figure 5603-2:	Headwater Depth for Concrete Pipe Culverts with Inlet Control	34
Figure 5603-3:	Headwater Depth for Oval Concrete Pipe Culverts, Long Axis Horizontal with Inlet Control	35
Figure 5603-4:	Headwater Depth for Oval Concrete Pipe Culverts, Long Axis Vertical with Inlet Control	36
Figure 5603-5:	Headwater Depth for Corrugated Metal Pipe Culverts with Inlet Control	37
Figure 5603-6:	Headwater Depth for Corrugate Metal Pipe – Arch Culvert with Inlet Control.....	38
Figure 5603-7:	Headwater Depth for Circular Pipe Culverts with Beveled Ring Inlet Control	39
Figure 5603-8:	Head for Concrete Pipe Culverts Flowing Full (n=0.12).....	40
Figure 5603-9:	Head for Concrete Box Culverts Flowing Full (n=0.012).....	41
Figure 5603-10:	Head for Oval Concrete Pipe Culverts, Long Axis Horizontal or Vertical Flowing Full (n=0.12).....	42
Figure 5603-11:	Head for Standard Corrugate Metal Pipe Culverts Flowing Full (n=0.024)	43
Figure 5603-12:	Head for Standard Corrugated Metal Pipe-Arch Culverts Flowing Full (n=0.024)	44
Figure 5603-13:	Head for Structural Plate Corrugated Metal Pipe Culverts Flowing Full (n=0.0328 to 0.0302).....	45
Figure 5603-14:	Head for Structural Plate Corrugated Metal Pipe Arch Culverts, 18 inch Corner Radius, Flowing Full (n=0.0328 to 0.0302).....	46
Figure 5604-1:	Curb Inlet (10' Throat) Minimum Hydraulic Dimensions.....	50
Figure 5604-2:	Type CG-1 Curb, S _x =2%, S _o =0.5%	51
Figure 5604-3:	Type CG-1 Curb, S _x =2%, S _o =1.0%	51
Figure 5604-4:	Type CG-1 Curb, S _x =2%, S _o =2.0%	52
Figure 5604-5:	Type CG-1 Curb, S _x =2%, S _o =3.0%	52
Figure 5604-7:	Type CG-1 Curb, S _x =2%, S _o =4.0%	53
Figure 5604-6:	Type CG-1 Curb, S _x =2%, S _o =6.0%	53
Figure 5604-8:	Type CG-1 Curb, S _x =2%, S _o =10.0%	54
Figure 5604-9:	Type CG-1 Curb, S _x =2%, S _o =8.0%	54
Figure 5604-10:	Type CG-1 Curb, S _x =2%, S _o =12.0%	55
Figure 5604-11:	Type CG-2 Curb, S _x =2%, S _o =0.5%	55
Figure 5604-12:	Type CG-2 Curb, S _x =2%, S _o =1.0%	56
Figure 5604-13:	Type CG-2 Curb, S _x =2%, S _o =2.0%	56
Figure 5604-14:	Type CG-2 Curb, S _x =2%, S _o =3.0%	57

Figure 5604-15:	Type CG-2 Curb, $S_x=2\%$, $S_o=4.0\%$	57
Figure 5604-16:	Type CG-2 Curb, $S_x=2\%$, $S_o=6.0\%$	58
Figure 5604-17:	Type CG-2 Curb, $S_x=2\%$, $S_o=8.0\%$	58
Figure 5604-19:	Type CG-2 Curb, $S_x=2\%$, $S_o=12.0\%$	59
Figure 5604-18:	Type CG-2 Curb, $S_x=2\%$, $S_o=10.0\%$	59
Figure 5604-20:	Nomograph for Flow in Triangular Channels	60
Figure 5604-21:	Capacity of Curb Opening Inlet at Sump.....	61
Figure 5605-1:	Typical Stream Characteristics (1 of 3)	62
Figure 5605-2:	Typical Stream Characteristics (2 of 3)	63
Figure 5605-3:	Typical Stream Characteristics (3 of 3)	63
Figure 5605-4:	Natural Channel Assessment.....	70
Figure 5605-5:	Natural Channel	71
Figure 5605-6:	Grade Control Structure	74
Figure 5606-1:	Hydraulic Elements of Circular Conduits.....	81
Figure 5607-1:	Permissible Shear Stresses for Non-Cohesive Soils	88
Figure 5607-2:	Permissible Shear Stresses for Cohesive Soils	89
Figure 5608-1:	Annual Sediment Storage	95

* * * * *

LIST OF TABLES

<u>Table</u>	<u>Page</u>	
Table 5601-1:	Level of Service for Street Crossings	8
Table 5602-1:	Antecedent Coefficient	11
Table 5602-2:	Documented Extreme Stream Flows in Kansas City Area and Surrounding Region	12
Table 5602-3:	Runoff Parameters	15
Table 5602-4:	Rainfall Mass.....	17
Table 5602-5:	Design Aide for Calculating Rainfall Intensity Kansas City Metropolitan Area	17
Table 5602-6:	Travel Time Estimates for Future Development.....	22
Table 5603-1:	Manning's Roughness Coefficient.....	28
Table 5603-2:	Head Loss Coefficients	29
Table 5604-1:	Inlet Configuration Dimensions	47
Table 5604-2:	Gutter Spread Criteria	47
Table 5604-3:	Inlet Bypass Spread Criteria	48
Table 5604-4:	Values of Coefficients and Exponent	49
Table 5605-1:	Stream Buffer Widths	64
Table 5605-2:	Critical Shear Stresses For Channel Materials	67
Table 5605-3:	Plan-Form Ratios	69
Table 5605-4:	Channel Condition Scoring Matrix.....	78
Table 5605-5:	Characteristics of Certain Plants for Bio-Engineering	80
Table 5606-1:	Energy Dissipation Counter Measures.....	82
Table 5607-1:	Permissible Shear Stresses for Lining Material.....	86
Table 5607-2:	Classification of Vegetal Covers as to Degree of Retardance	87
Table 5609-1:	Drawing Scales	98

* * * * *

DIVISION V
DESIGN CRITERIA
SECTION 5600 STORM DRAINAGE SYSTEMS & FACILITIES

SECTION 5601 ADMINISTRATIVE

5601.1 Introduction

These criteria provide uniform procedures for designing and checking the design of storm drainage systems under the rainfall and land characteristics typical of the Kansas City Metropolitan Area. This manual generally focuses on water quantity concerns including: conveyance, flow rates, and construction design parameters of stormwater systems. For an in-depth discussion of water quality design standards and Best Management Practices (BMPs) for the Kansas City Metropolitan area see the “Mid-America Regional Council and American Public Works Association; Manual for Best Management Practices for Stormwater Quality”.

Federal law requires that “Waters of the United States may be disturbed only after permission is received from the City/County and permitted by the U.S. Army Corps of Engineers, if applicable. A jurisdictional determination by the U.S. Army Corps of Engineers shall be obtained prior to beginning design.” Besides federal guidelines, specific criteria have been developed and are applicable to the types of drainage systems and facilities ordinarily encountered in local urban and suburban areas. Other special situations may be encountered that require added criteria or more complex technology than included herein such as maintaining or improving water quality. Any design procedure conforming to current accepted engineering practice may be used for the design of storm drainage systems in lieu of the computation methods presented in this manual, providing equivalent results are obtained and have been approved by the City/County Engineer. Drainage systems for all developments shall be designed assuming ultimate or built-out land-use conditions. The decision flowchart in Figure 5601-1, “Guide to Stormwater Management for Site Development”, shall be used to determine the appropriate runoff controls (see end of this section).

5601.2 Definitions

Best Management Practice (BMP): Stormwater management practice used to prevent or control the discharge of pollutants to water of the U.S. BMPs may include structural or non-structural solutions, a schedule of activities, prohibition of practices, maintenance procedures, or other management practices. For a comprehensive discussion on BMPs refer to the “Mid-America Regional Council and American Public Works Association; Manual for Best Management Practices for Stormwater Quality”.

City/County: The municipality or body having jurisdiction and authority to govern.

City/County Engineer: The municipal or county public works official or body having jurisdiction and authority to review and approve plans and designs for storm drainage systems.

Channel Lining: Includes any type of material used to stabilize the banks or bed of an engineered channel.

Design Storm: The combination of rainfall depth, duration, and distribution of a hypothetical rainfall event with a given likelihood of occurring in any year.

Detention Facility: A storm water management facility controlling storm water runoff from a site or watershed. The allowable runoff specified for detention facilities in Section 5608 is intended to manage maximum storm water release rates to minimize flooding and downstream erosion.

Detention Storage: The volume occupied by water above the level of the principal spillway crest during operation of a stormwater detention facility.

Developer: Any person, partnership, association, corporation, public agency, or governmental unit proposing to or engaged in "development".

Development: Any activity, including subdivision, that alters the surface of the land to create additional impervious surfaces, including, but not limited to, pavement, buildings, and structures. Refer to Section 5601.3 for applicability.

Dry Detention: A detention facility that is designed for the temporary storage of water to control discharge rates from the facility and is normally dry between rainfall events.

Easement: Authorization by a property owner for the use by another for a specified purpose, of any designated part of the property.

Emergency Spillway: A device or devices used to discharge water under conditions of inflow that exceed the design outflow from the primary spillway detention facility. The emergency spillway functions primarily to prevent damage to the detention facility that would permit the sudden release of impounded water.

Engineer: See 'Registered Professional Engineer'.

Engineered Channel: An open drainage channel that has been explicitly designed to convey stormwater runoff in accordance with Section 5607 or as approved by the City/County engineer.

FHWA: Federal Highway Administration.

Floodplain: A relatively level surface of stratified alluvial soils on either side of a watercourse that is inundated during flood events.

Freeboard: The difference in elevation between the top of a structure such as a dam or open channel and the maximum design water surface elevation or high water mark. It is an allowance against overtopping by waves or other transient disturbances.

Impact Stilling Basin: A device that dissipates energy by allowing flowing water to strike a stationary surface therefore producing turbulence and energy loss. .

Impervious Surface: A surface that prevents the infiltration of stormwater.

Improved Channel: Any channel changed by grading or the construction of lining materials as approved by the City/County Engineer.

Incision: Adjustment of the channel bed elevation downwards, typically in response to some type of disturbance.

Increased Runoff: Increase in volume or peak flow of stormwater runoff.

Meander Amplitude: The linear distance between the apex of one meander and the apex of the next meander in a naturally curving stream.

Meander Length: The length measured along the thalweg of one complete waveform.

Meander Wavelength: The length of one complete waveform, measured as the straight-line linear distance along the valley between two analogous points on a waveform.

Low-Drop Structures: A step pool energy dissipation structure typically constructed out of rock or concrete with a design vertical drop of 2 feet or less per step.

Natural Channel: Any waterway with the ability to self-form by virtue of having at least one unfixed boundary. This includes drainage ways that may have been previously disturbed but through inactivity over time have begun to reform one or more characteristics of undisturbed streams.

Open Channel: A maintained earthen or lined waterway with an open water surface as approved by the City/County engineer.

Ordinary High Water Mark: A line on the bank established by the fluctuations of water and indicated by physical characteristics such as clear, natural line impressed on the bank, shelving, changes in the character of soil, destruction of terrestrial vegetation, the presence of litter and debris, or other appropriate means that consider the characteristics of the surrounding areas.

Owner: The owner of record of real property.

Point Bars: Depositional features generally occurring on the inside of stream bends and opposite cut banks.

Pools: A deep reach of a stream. The reach of a stream between two riffles; a small and relatively deep body of quiet water in a stream or river.

Primary Outlet Works: A device such as an inlet, pipe, weir, etc., used to discharge water during operation of a storage facility under the conditions of the 1% storm or more frequent event.

Principal Stream: Stream Segments included in FEMA Flood Insurance Studies where the limits of the 1% floodplain and 1% base flood elevations have been determined.

Redevelopment: Remodeling, repair, replacement, or other improvements to any existing structure, facility, or site.

Registered Professional Engineer: A licensed engineer who is registered with and authorized to practice engineering within the state of registration.

Riffles: Shallow rapids in an open stream, where the water surface is broken into waves by obstructions such as natural channel armoring or bedrock outcrop wholly or partly submerged beneath the water surface.

Sediment Storage: The volume allocated to contain accumulated sediments within a detention facility.

Site: A tract or contiguous tracts of land owned and/or controlled by a developer or owner. Platted subdivisions, industrial and/or office commercial parks, and other planned unit developments shall be considered a single site. This shall include phased development where construction at a tract or contiguous tracts of land may occur in increments.

Storm: A rainfall event used for design which is defined by the probability such an event will be equaled or exceeded in any one year. When designing in accordance with these criteria, the storm event probabilities used are: 1%, 2%, 4%, 10% and 50%

Storm Drainage System: All of the natural and man-made facilities and appurtenances such as ditches, natural channels, pipes, culverts, bridges, open improved channels, swales, street gutters, inlets, and detention facilities which serve to convey surface drainage.

Swale: An engineered channel conveying stormwater from more than two lots; often the swale is maintained by the property owner but an easement is required when requested by the City/County.

Thalweg: The deepest part of a channel cross-section. The dominant thread of stream flow creates the thalweg.

Tributary Area: All land draining to the point of consideration, regardless of ownership.

Watershed: All the land area that drains to a given point.

Waveform: A complete cycle of two channel bends in opposite directions.

Wet Detention Facility: A detention facility that is designed to include permanent storage of water in addition to the temporary storage used to control discharge rates from the facility.

5601.3 General Requirements and Applicability

The design shall be accomplished under the direction of a Registered Professional Engineer qualified in the field of stormwater design. The design shall be based on land use in the tributary area as zoned, actually developed, or indicated by an adopted future land use plan, whichever basis produces the greatest runoff.

This design criterion shall apply to all development, including subdivision, which alters the surface of the land to create additional impervious surfaces, including, but not limited to, pavement, buildings, and structures with the following exceptions:

A. Redevelopment, Expansion, Renovation, Repair and Maintenance Activities Listed Below

1. Additions to, improvements, and repair of existing single-family and duplex dwellings.
2. Remodeling, repair, replacement, or other improvements to any existing structure or facility and appurtenances that does not cause an increased area of impervious surface on the site.
3. Remodeling, repair, replacement or other improvements to any existing structure or facility and appurtenances on sites smaller than two acres that does not cause an increased area of impervious surface on the site in excess of 10 percent of that previously existing.
4. Remodeling, repair, replacement, or other improvements to any existing structure or facility and appurtenances that does not cause an increased area of impervious surface on the site in excess of 10 percent of that previously existing, provided the total impervious area of the site is less than 5,000 square feet. (See "Site Planning for Urban Stream Protection" provided by the "Center for Watershed Protection" for a discussion on imperviousness and its effect on watershed health; <http://www.cwp.org/SPSP/TOC.htm>).

B. New Construction Meeting the Following Criteria

1. Construction of any one new single family or duplex dwelling unit, irrespective of the site area on which the structure may be situated, provided the total impervious area of the site is less than 5,000 square feet.
2. Construction of any buildings, structures, and/or appurtenant service roads, drives, and walks on a site having previously provided stormwater management, as defined in Section 5601.5 A4 as part of a larger unit of development, OR a site previously relieved of stormwater management requirements.

5601.4 Existing Drainage System

Existing drainage system component pipes, structures, and appurtenances within the project limits may be retained as elements of an improved system providing:

- They are in sound structural condition.
- Their hydraulic capacity, including surcharge, is equal to or greater than the capacity required by these criteria.
- Easements exist or are dedicated to allow operation and maintenance.

Discharge from an existing upstream storm drainage system shall be computed assuming its capacity is adequate to meet the performance criteria listed in Section 5601.8. The computed discharge shall be used to design the new downstream system even if the actual capacity of the existing upstream system is less.

5601.5 System Types and Applications

- A. **General Guidelines:** Natural channels are to be preserved to the maximum extent practicable as site conditions permit. Design standards for natural channels are addressed in Section 5605. Engineered channels, the next highest priority system component, shall be designated and coordinated with the design

of building lots and streets in accordance with the design criteria and performance standards addressed in section 5607.

To the maximum extent possible, drainage systems, street layout and grades, lot patterns and placement of curbs, inlets and site drainage, and overflow swales shall be concurrently designed in accordance with the design criteria and performance standards set forth in this document. Curb and gutter may be omitted or modified where approved by the City/County Engineer and deemed feasible in conjunction with other stormwater management practices including water quality BMPs.

Enclosed conveyance systems consisting of inlets, conduits, and manholes may be used to convey stormwater runoff where site conditions and open space requirements will not permit the use of natural or engineered channels. Where used, such systems must be designed in accordance with design criteria and performance standards addressed in section 5606.

Generally, a drainage system is engineered and constructed when the drainage area exceeds 2 acres.

1. **Open Systems:** Where feasible, open systems consisting of open or engineered channels shall be used if all of the following design criteria and the conditions of Section 5601.8 are met:
 - a. The channel slope is less than or equal to 5 percent or where appropriate armoring techniques are used to prevent erosion.
 - b. The 50% storm velocity is less than or equal to 5 feet per second (fps) or where appropriate armoring techniques are used to prevent erosion.
 - c. When 60 feet or farther away from top of bank to any existing or proposed habitable building, regardless of system design capacity.
2. **Enclosed Systems:** Enclosed systems consisting of underground pipes, culverts, and similar underground structures shall be used to convey stormwater at all locations whenever one of the following design criteria and the conditions of 5601.8 are met:
 - a. Where natural channels or open systems are not feasible per the requirements set forth in Section 5605 and Section 5601.5-A1
 - b. Within the right-of-way of streets with curbs, regardless of system design capacity.
3. **Overflow Systems:** Each conveyance element of the stormwater drainage system (whether open, enclosed, or detention) shall include an overflow element. Overflow systems shall:
 - a. Be designed to route downstream any amount of the 1% storm exceeding the in-system design capacity specified in Section 5601.8.
 - b. Include streets, engineered channels, redundant piping, spillways, parking lots, drives or combinations thereof.
 - c. Limit the maximum water surface elevation generated by the 1% storm as specified in Section 5601.8.
 - d. Conform to local standards regarding dedicated easements and/or restricted uses for overflow systems; consult with the local authority for requirements.
 - e. Be limited to the natural drainage basins, unless overflows transferred out of a natural drainage basin (e.g. a thoroughfare straight-graded through a drainage basin with a sump in another drainage basin) are added to the overflows in the receiving drainage basin and the combined overflow still meets the criteria at 5601.5 A 3C
4. **Stormwater Management:** New development or redevelopment as defined in Section 5601.2 shall incorporate stormwater management measures to control runoff from the site. Allowable runoff from a site may be limited by the need to minimize downstream flood damage, prevent erosion, and/or

minimize impacts to the ecology and water quality of the downstream drainage system. It is recognized for site-level runoff controls to be effective, consistent application across a watershed is necessary to realize measurable benefits along the downstream system. This section presents four site runoff control strategies that can be applied to sites within a watershed based on watershed protection goals and identified problems. The City/County or local authority shall pre-determine which strategy is to be applied within its watersheds or subsheds. If watershed control strategies are not defined by the local authority, the default strategy for new development shall be the Comprehensive Protection strategy.

a. Default Strategy: Comprehensive Protection

Under this strategy, peak runoff control is provided for the 1%, 10% and 50% chance storms and volumetric and/or extended detention control of the 90% mean annual event storm for broad protection of the receiving system, including channel erosion protection and flood peak reductions over a range of return periods. This strategy shall be the default strategy unless otherwise designated or approved by the local authority. Performance standards and sizing criteria are provided in Section 5608.

b. Reduced Control Strategies

1) **Frequent Event Control for Stream Erosion Protection:** This strategy provides runoff control for the 10% and 50% chance storms and volumetric and/or extended detention control of the 90% mean annual event storm in order to protect downstream channels from erosion. This strategy is appropriate for largely undeveloped watersheds containing natural streams where downstream flooding of existing structures is not present and would not occur under future upstream full-development conditions.

2) **Extreme Flood Event Control Only:** Under this strategy, detention is provided solely to reduce peak runoff rates for the 10% and 1% storm events. Over-detention of the peak release rates at the discharge point (i.e. requiring the post-development rate to be less than the pre-development rate) is used to ensure a cumulative benefit for a reasonable distance downstream. If known flooding occurs downstream in flood events more frequent than the 10% event, the local authority may require control of these events.

This strategy is not effective at protecting stream channels and banks from erosion. It is most applicable in certain redevelopment and in-fill situations where flooding problems are known, existing downstream stream conditions are already poor, and economic barriers to redevelopment preclude more extensive control.

3) **Special Locally-Defined Strategies:** The City/County may develop alternative strategies that are tailored to the unique circumstances of their watersheds. Such strategies may apply globally to the City/County or only to certain designated areas. The City/County will identify each alternative strategy with a unique descriptor and publish the requirements for each.

Such alternative strategies may involve increased or decreased allowable release rates, relaxed or more stringent controls for certain storm return intervals, reliance on infiltration or low-impact development practices for added volume control, planning and open space controls, and/or special requirements to participate in regional control facilities instead of development-scale facilities.

Stormwater management for site development may include structural facilities and/or non-structural solutions. Where runoff controls are required, low-impact development practices or, off-site control of runoff in addition to or instead of the standard wet or dry bottom basins may be used.

5601.6 Waivers

The Developer may submit a study by a registered professional engineer that quantifies the problems and demonstrates that a waiver (exemption) of the requirement to provide stormwater management is appropriate. The City/County Engineer may waive requirements to address *unique* conditions or constraints:

- A. Stormwater Management Facilities:** Stormwater management facilities may be waived and/or release rates other than those permitted by Section 5608 when supported by a developer's Drainage Study performed in accordance with Section 5609 and approved by the City/County Engineer.
- B. Overflow Channels:** In previously developed areas, requirements to provide for 1% storm conveyance may be reduced by the City/County Engineer in circumstances where flood protection for the 1% storm is not reasonably attainable due to the location of damageable improvements with respect to the drainage system and where non-attainment is supported by an approved Drainage Study.

5601.7 Other Requirements

Rules and regulations of other agencies also pertain to drainage systems which may or may not complement these criteria. When conflicts are encountered, the more stringent criteria shall govern.

The following agencies have jurisdiction over streams and/or drainage systems and often require permits. Other regulations, permits and requirements may not be limited to these agencies.

- Federal Emergency Management Agency.
- U.S. Army Corps of Engineers.
- Missouri Department of Natural Resources.
- Kansas Department of Agriculture – Division of Water Resources.
- Kansas Department of Health and Environment
- Municipal Ordinances.

5601.8 Levels of Service

Drainage systems shall be designed to meet all levels of service described below. In addition, natural streams include requirements specified in Section 5605.

A storm drainage system shall be provided that is capable of conveying the peak discharge generated by the 1% storm. If the in-system capacity established in this section is less the 1% storm peak discharge, then an overflow system as specified in Section 5601.5 -A-3 may provide the additional system capacity.

A. Protection of Property

1. Property not reserved or designed for conveying storm water shall be protected from frequent inundation:
 - a. When the total drainage area is less than 2 acres, protection may be provided by following good lot grading practices or by one of the conveyances described below.
 - b. When the total drainage area is 2 acres or more, one of the following conveyances must be used to convey the 10% storm:
 - 1) Pipe system conveying the design storm under a regime of pressure flow with no overflow at inlets or manholes, or
 - 2) An engineered open channel conveying the 10% storm at bank full
 - 3) A street gutter
 - 4) A natural stream

2. Buildings shall be protected from infrequent flooding by:
 - a. Providing a minimum of one-foot freeboard above the 1% storm stage, at any point along the drainage system, for openings in a building. For lakes and detention basins the 1% storm stage will be the water surface of flow through the emergency spillway.
 - b. Flood-proofing a building below the 1% storm water surface elevation plus one foot of freeboard, in accordance with the current edition of the International Building Code or as required by the City/County.
 - c. Non habitable accessory buildings are sometimes provided less protection by local City/County ordinances or policies. Consult the local authority for exceptions.

B. Protection for Streets

1. **Gutter Spread:** Water spread in streets shall meet the requirements in Section 5604.2 for the 10% design storm. These values are intended to establish a standard of accessibility for the widths (classes) of roadways listed during the 10% storm. When the local jurisdiction requires a higher standard for curb inlets, the conveyance system connected to the roadway must also meet that higher standard. If the roadway conveyance system connects to an underground system with lesser capacity, the system must be constructed to allow the discharge of that excess capacity into the overflow system.
2. **Street Crossings:** Concentrated flow not conveyed in the gutter system, shall be conveyed under streets to prevent vehicles from being swept from the roadway in infrequent storms. These crossings may be bridges, culverts or underground systems. A common practice is to construct the low point in the roadway so that it does not fall on the bridge or culvert. This practice protects the structure from damage in an overflow condition, but does not change this requirement. Crossings will be designed to completely convey flood flows without street overtopping in accordance with Table 5601-1.

Table 5601-1: Level of Service for Street Crossings

<u>Street Classification</u>	<u>Min. Design Storm Capacity</u>
Arterial	2%
Collector	4%
Residential	10%
Residential with open channel downstream	4%

Further, concentrated flow in excess of the minimum design storm may only overtop the roadway if the following conditions are met:

- a. The span of the structure opening is less than 20 feet.
- b. The peak stormwater runoff from the 1% storm is 250 cfs or less unless a guard fence is installed on the downstream side of the roadway.

Such overflow depths at low points in roadways during the 1% storm will be limited to 7 inches measured at the high point in the roadway cross section; except that it also shall not exceed 14 inches at the deepest point in the roadway cross section. Depths may be limited where necessary by reverse grading the downstream right of way area, by lengthening the vertical curve of the roadway, by reducing roadway crown, or by other similar means. Roadway overtopping depths shall be determined by integrating the broad crested weir formula across the roadway profile. Each incremental flow can be determined by using the formula:

$$q = C \cdot l \cdot h^{2/3}$$

Where:

- q = the flow for an increment of profile length (width of flow)
- l = the incremental width
- C = a flow coefficient that shall not exceed 3.0
- h = the average depth of flow at each increment

The total flow Q is the sum of the incremental flows. Depth determinations can be made through an iterative process where successive depths are chosen; Q is calculated for each depth and then compared to the known Q at the overtopping point.

Overflow protection criteria provides additional accessibility criteria at major stream crossings for emergency personnel, and provides the public with protection against injury and property damage.

C. Downstream Impacts

1. The negative impacts of development on flooding problems in the downstream system shall be mitigated through detention as specified in Section 5601.5-A-4, or through other means approved by the City/County.
 - a. Impacts on natural channels are regulated in Section 5605.
 - b. Communities that have adopted the recommended "Manual of Best Management Practices (BMPs) for Stormwater Quality" should also mitigate the negative impact of development on natural channels through the installation of water quality BMPs and closely adhere to practices specified in Section 5605 on natural channels.

D. Adjoining Property: State and Federal regulations often establish requirements for a storm drainage project that impacts adjoining property, especially when a project causes a rise in water surface elevations. In addition to all Federal and State regulations the following shall be met:

1. **Drainageways not designated a Special Flood Hazard Area (FEMA 1% Floodplain):** Construction of a storm drainage system, including grading and filling within a natural drainage way, requires agreement from adjoining property owners if the work will cause a rise in the water surface elevation on the adjoining property for the 1% storm. Agreement shall be considered granted by recording a document which reserves the affected property for inundation during the 1% storm, or by other means approved by the City/County.
2. **Drainageways designated a Special Flood Hazard Areas (FEMA 1% Floodplain) and City/County participates in the National Flood Insurance Program:** When impacting adjoining properties, refer to the local community's adopted Floodplain Management Ordinance for any requirements, in addition to all current FEMA regulation.

Figure 5601-1: Guide to Stormwater Management for Site Development

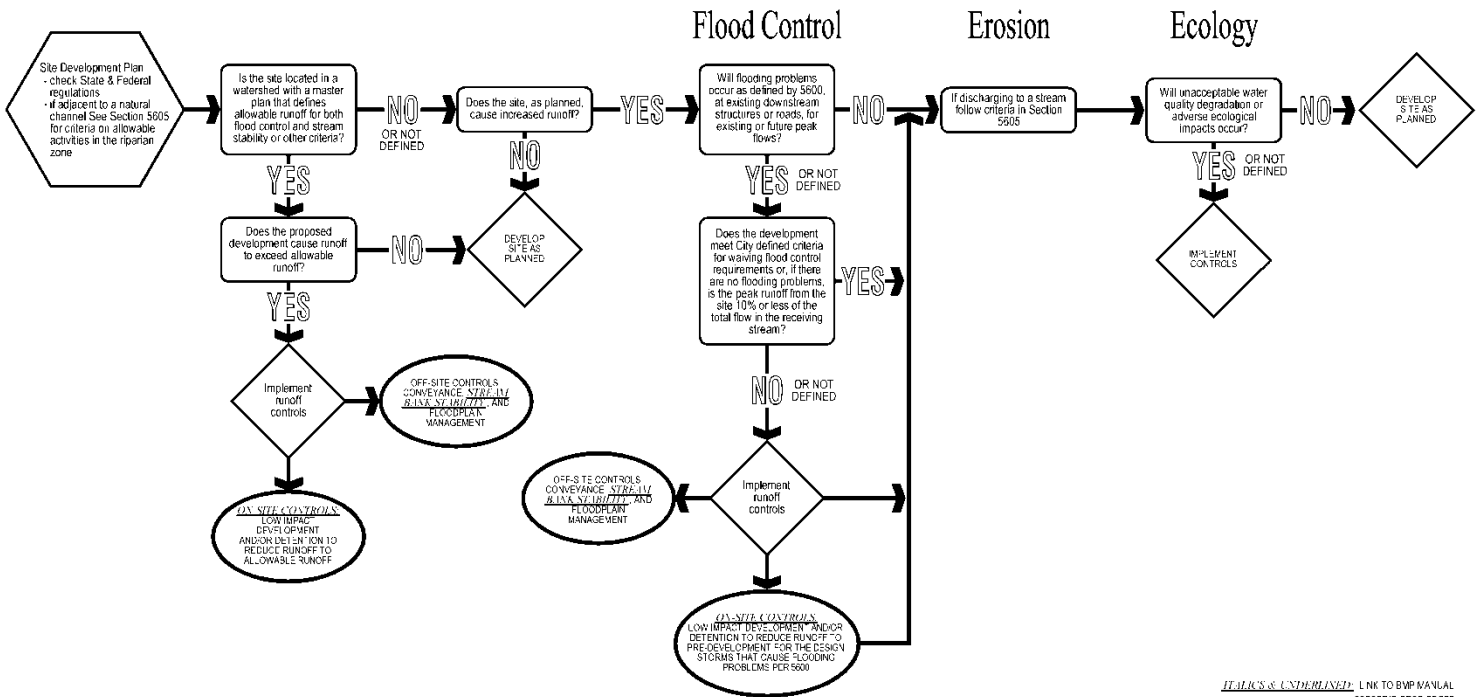

- ITALICS & UNDERLINED: LINK TO BWP MANUAL
- conserve open space
 - swales to lengthen Tc
 - infiltration
 - bioretention
 - vegetative strips
 - rain gardens
 - wetlands
 - low impact development
 - stream buffers

SECTION 5602 HYDROLOGY

5602.1 Scope

This section sets forth the hydrologic parameters to be used for computations involving the definition of runoff mass and peak rates to be accommodated by the storm drainage system. The methods to be used for calculating runoff mass and peak rates are intended for the design of drainage systems. Refer to the "Mid-America Regional Council and American Public Works Association; Manual for Best Management Practices for Stormwater Quality" for design methods and calculations of runoff water quality.

5602.2 Computation Methods for Runoff

Runoff rates to be accommodated by each element of the proposed storm drainage system shall be calculated using the criteria of this section for land use runoff factors, rainfall, and system time. The following methods of computations are allowed:

- A. Watersheds Less than 200 Acres:** The Rational Method may be used to calculate peak rates of runoff to elements of enclosed and open channel systems, including inlets, when the total upstream area tributary to the point of consideration is less than 200 acres. The Rational Method is defined as follows:

$$Q = K \cdot C \cdot i \cdot A$$

Where:

- Q = Peak rate of runoff to system in cfs
C = Runoff coefficient as determined in accordance with Paragraph 5602.3
i = Rainfall intensity in inches per hour as determined in accordance with Paragraph 5602.6
K = Dimensionless coefficient to account for antecedent precipitation as follows, except the product of C·K shall not exceed 1.0. See Table 5602-1.

Table 5602-1: Antecedent Coefficient

<u>Design Storm</u>	<u>K</u>
10% and more frequent	1.0
4%	1.1
2%	1.2
1%	1.25

- B. Baseline Unit Hydrograph Method:** The following computer implementations of the unit hydrograph method are acceptable for all watersheds:

- SCS Technical Release No. 55 "Urban Hydrology for Small Watersheds", 2nd Edition, June 1986.
- 2. SCS Technical Release No. 20 "Project Formulation - Hydrology", 2nd Edition, May 1983.
- 3. U.S. Army Corps of Engineers, Hydrologic Engineering Center - "HEC-1Flood Hydrograph Package".
- 4. U.S. Army Corps of Engineers, Hydrologic Engineering Center - "HEC-HMS Hydrologic Modeling System", current version.

Copies of the above publications and micro-computer programs based thereon are available for purchase through National Technical Information Service, U.S. Department of Commerce, Springfield, VA 22161.

Inputs for unit hydrograph procedures shall conform to the requirements of sections 5602.3 through 5602.8.

- C. Kansas “Calibrated” Design Method:** In lieu of the input parameters set forth in sections 5602.3 through 5602.8, an alternative unit hydrograph method using HEC-1 or HEC-HMS and conforming to recommendations based on research conducted at the University of Kansas for gauged basins in Kansas (McEnroe and Zhao, August 2001 and McEnroe and Gonzalez, July 2002) are allowed. Such alternate procedures must use the appropriate total combinations of HEC-1 hypothetical storm distributions, storm durations, antecedent moisture conditions, unit hydrograph peaking coefficients, and basin lag times as calibrated in the research. All other computations shall be given as required in this standard.

Antecedent moisture condition adjustments shall be made only to the pervious component of a watershed, direct conversion of composite antecedent moisture conditions is not appropriate.

- D. Other Alternative Design Methods:** Alternative design methods, including computer models and Kansas “Calibrated” Design Method, may be employed so long as they produce runoff hydrographs to the system that are substantially the same or more conservative than those calculated by the baseline method. To assess the equivalence of such methods, the Engineer shall prepare estimates using both the alternate design method and the baseline unit hydrograph method, and shall report for every sub-basin the following data from both: peak flow rate, lag time, runoff volume, and equivalent curve number based on total storm precipitation and direct runoff. Any discrepancy greater than 5% between the two models shall be clearly identified, and discrepancies that produce less conservative results shall be justified. Testing of equivalence is not required if the alternative method has been proven to the City/County engineer to be consistently more conservative than the baseline unit hydrograph method or if the City/County Engineer has determined that the alternative method is reliably more accurate or appropriate for the design condition.

- E. Regression Formulas:** Rural regression formulas prepared by the U.S. Geological Survey for Kansas (Rasmussen and Perry, 2000) and Missouri (Alexander and Wilson, 1995) and urban regression formulas prepared for nationwide use (Sauer, Thomas, Stricker, and Wilson, 1983) or Missouri use (Becker, 1986), or their subsequent revisions, shall not be used as the sole input for project design, but are useful tools for evaluating design models. Rural regression formulas shall be used only to represent rural or pre-development conditions when significant basin storage does not exist. The Kansas rural regression formula produces substantially more conservative peak flow estimates than the Missouri equation and should be used unless specifically allowed otherwise by the City/County. For urban watersheds, the rural regression results can be used as inputs to the urban regression formula, or a pre-development scenario of the basin model can be developed to compare to the rural regression, and then physically realistic adjustments can then be made to impervious percentages, ground cover, basin lag times, and channel routing to produce the urban scenario. Figures 5602-4 and 5602-5 show typical results for Kansas and Missouri, including a summary of the gauge data estimates used to derive the equations. Table 5602-2 and Figures 5602-6 and 5602-7 present documented extreme stream flows in Kansas City and other areas. Engineers shall use caution in interpreting regression formula results and acknowledge the range of standard error and uncertainty of both the regression formulas and the underlying gauge estimates.

Table 5602-2 Documented Extreme Stream Flows in Kansas City Area and Surrounding Region

ID No.	USGS Station Number	Station Name	Contributing Drainage Area (sq. miles)	Date of Max. Discharge	Max. Recorded Discharge (cfs)	Max. Discharge per Basin Area (cfs/acre)	Period of Record (Water Yr.)	References
Kansas City Metropolitan Area, Missouri and Kansas								
1.	06821130	First Creek near Nashua	0.55	18-May-74	1,250	3.6	1959-84	1,7

Table 5602-2 Documented Extreme Stream Flows in Kansas City Area and Surrounding Region

ID No.	USGS Station Number	Station Name	Contributing Drainage Area (sq. miles)	Date of Max. Discharge	Max. Recorded Discharge (cfs)	Max. Discharge per Basin Area (cfs/acre)	Period of Record (Water Yr.)	References
2.	--	Turkey Creek trib. at Carter St. at Merriam, Ks.	0.82	12-Sep-77	1,200	2.3	--	3
3.	--	Little Blue River trib. at Noland Road at Independence, Mo.	0.83	12-Sep-77	2,330	4.4	--	3
4.	--	Rock Creek at Woodson and Martway St. at Mission, Ks.	1.15	12-Sep-77	1,980	2.7	--	3
5.	--	Tucker Creek at Highway FF near Grain Valley, Mo.	1.45	12-Sep-77	1,890	2.0	--	3
6.	--	Brush Creek at 75th and Nall at Prairie Village, Ks.	1.51	12-Sep-77	3,000	3.1	--	3
7.	--	White Oak Creek at Raytown, Mo. (Raytown Road)	1.78	12-Sep-77	2,290	2.0	--	3
8.	--	Cedar Creek at Lee's Summit, Mo. (Chicago-Rock Island and Pacific RR)	1.84	12-Sep-77	2,410	2.0	--	3
9.	06893710	Cates Branch near Liberty, Mo. (Sherril Drive)	1.95	12-Sep-77	2,480	2.0	--	3
10.	--	Mill Creek near Independence, Mo. (Courtney Road)	1.95	12-Sep-77	2,240	1.8	--	3
11.	--	Rock Creek at Sheridan Road at Fairway, Ks.	3.04	12-Sep-77	4,900	2.5	--	3
12.	--	Blue River trib. at Bannister Road near Kansas City, Mo. (U.S. Hwy 71)	3.38	13-Sep-77	4,040	1.9	--	3
13.	06893600	Rock Creek at Independence, Mo.	5.2	12-Sep-77	7,760	2.3	1967-75	3,7
14.	--	Brush Creek at 73rd St. and Mission Hills, Ks.	5.84	12-Sep-77	14,400	3.9	--	3
15.	06893570	Round Grove Creek at Raytown Road at Kansas City, Mo.	5.87	Sep-77	13,200	3.5		3
16.	06892800	Turkey Creek at Merriam, Ks. (67th St.)	6.76	12-Sep-77	5,300	1.2	1974-86	3,7
17.	--	Turkey Creek at Merriam, Ks. (63rd St.)	7.84	12-Sep-77	6,490	1.3	--	3
18.	06893560	Brush Creek at Main St. at Kansas City, Mo.	14.89	12-Sep-77	17,600	1.8	1971-79	3,7
19.	06894500	East Fork Fishing River at Excelsior Springs, Mo.	20	6-Jul-51	12,000	0.9	1951-72	1,2,7
20.	06892940	Turkey Creek at Kansas City, Ks. (State Hwy. 10)	22.3	1-May-83	12,500	0.9	1974-87	3,7
21.	06893350	Tomahawk Creek near Overland Park, Ks.	23.9	13-Aug-82	8,250	0.5	1970-82	4
22.	06893300	Indian Creek at Overland Park, Ks. (Marty St.)	26.6	9-Jun-84	12,800	0.8	1964-01	4
23.	06894680	Sni-A-Bar Creek near Tarsney, Mo. (Colburn Road)	29.1	12-Sep-77	15,700	0.8	1970-79	3,7
24.	--	Fishing Creek near Kearney,	39.4	22-Jun-47		1.2	--	2

Table 5602-2 Documented Extreme Stream Flows in Kansas City Area and Surrounding Region

ID No.	USGS Station Number	Station Name	Contributing Drainage Area (sq. miles)	Date of Max. Discharge	Max. Recorded Discharge (cfs)	Max. Discharge per Basin Area (cfs/acre)	Period of Record (Water Yr.)	References
		Mo.			30,000			
25.	06893080	Blue River near Stanley, Ks.	46	15-May-90	20,200	0.7	1970-01	4
26.	06893793	Little Blue River (below Longview Road Dam) at Kansas City, Mo.	50.7	13-Aug-82	18,700	0.6	1967-99	1,3,7
27.	" "	" " (2nd highest peak)	50.7	13-Sep-77	18,100	0.6	" "	1,3,7
Kansas, outside the Kansas City Metropolitan Area								
28.	--	Dry Walnut Creek trib. near Great Bend	1.19	15-Jun-81	3,080	4.0	--	4
29.	06889100	Soldier Creek near Goff	2.06	10-May-70	7,080	5.4	--	2,4
30.	--	Dry Walnut Creek trib. near Great Bend	2.28	15-Jun-81	5,720	3.9	--	4
31.	06912300	Dragoon Creek trib. near Lyndon	3.76	11-Jun-81	8,200	3.4	--	4
32.	06879650	Kings Creek near Manhattan	4.09	13-May-95	10,200	3.9	--	4
33.	07166700	Burnt Creek at Reece	8.85	9-Jun-65	20,500	3.6	--	2,4
34.	--	Mill Creek near Alta Vista	18.7	1951	19,800	1.7	--	6
35.	07184600	Fly Creek near Faulkner	27	3-Jul-76	28,000	1.6	1957-77	4
36.	06815600	Wolf River near Hiawatha	41	9-Aug-68	40,000	1.5	--	4
37.	07179600	Four Mile Creek near Council Grove	55	26-Jun-69	68,100	1.9	1964-77	4
38.	07181500	Middle Creek near Elmdale	92	27-Jun-69	60,000	1.0	'17, 38-90	4
Missouri, Outside the Kansas City Metropolitan Area								
39.	--	Nemo Branch at Nemo	0.52	30-May-56	1,950	5.9	--	2
40.	07011500	Green Acre Branch near Rolla	0.62	9-Jun-50	1,900	4.8	1948-75	1,2,7
41.	--	Boney Draw at Rockport	0.76	18-Jul-65	5,080	10.4	--	2
42.	--	Clear Creek tributary near Holt	6.52	22-Jun-47	14,000	3.4	--	2
43.	07019790	Plattin Creek at Plattin	65.8	Jun-64	36,800	0.9	1966-72	2,7
Midwest, Outside Missouri and Kansas								
44.	--	East Fork Big Creek near Bowlegs, Okla.	0.89	14-Apr-45	3,000	5.3	--	2

Table 5602-2 Documented Extreme Stream Flows in Kansas City Area and Surrounding Region

ID No.	USGS Station Number	Station Name	Contributing Drainage Area (sq. miles)	Date of Max. Discharge	Max. Recorded Discharge (cfs)	Max. Discharge per Basin Area (cfs/acre)	Period of Record (Water Yr.)	References
45.	--	Stratton Creek near Washta, Iowa	1.9	9-Aug-61	11,000	9.0	--	2
46.	--	West Fork Big Blue River trib. near York, Nebr.	6.9	9-Jul-50	23,000	5.2	--	2
47.	08057140	Cottonwood Creek at Forest Lane, Dallas, Tx.	8.5	28-Apr-66	17,600	3.2	1962-78	5,7
48.	--	Ranch Creek near Halley, Okla.	17.1	4-Sep-40	32,400	3.0	--	2

References Cited:

- Alexander and Wilson. Technique for Estimating the 2-to 500-Year Flood Discharges on Unregulated Streams in Rural Missouri. USGS WRIR 95-4231. 1995
- Crippen and Bue. Maximum Floodflows in the Conterminous United States. USGS WSP 1887. 1977.
- Hauth. Floods in Kansas City, Missouri and Kansas, September 12-13, 1977. USGS Prof. Paper 1169. 1981.
- Rasmussen and Perry. Estimate of Peak Streamflows for Unregulated Rural Streams in Kansas. USGS WRIR 00-4079. 2000.
- Sauer et al. Flood Characteristics of Urban Watersheds in the United States. USGS WSP 2207. 1983.
- USGS. Kansas-Missouri - Floods of July 1951. USGS WSP 1139. 1952.
- USGS. Surface-Water Data for the Nation. Peak flow database at <http://waterdata.usgs.gov/nwis/sw>. Queried January 2003.

5602.3 Runoff Coefficients

- A. Basis of Curve Number Coefficients:** All Curve Number coefficients in this section are values for Hydrologic Group "C" soils. For soils in other Hydrologic Groups, equivalent SCS Curve Numbers can be found in SCS Technical Release No. 55. No soil disturbed by construction shall be assigned a Hydrologic Group classification of 'A' or 'B'.
- B. Standard Land Use/Zoning Classifications:** Runoff Coefficients relative to development, undeveloped land and land use shall have the values indicated in Table 5602-3.

Table 5602-3: Runoff Parameters

Land Use / Zoning	Average Percent Impervious	Average Percent Pervious	Rational Method "C"	SCS Curve Number
Business				
Downtown Area	95	5	0.87	97
Neighborhood Areas	85	15	0.81	94
Residential				
Single Family Areas	35	65	0.51	82
Multifamily Areas	60	40	0.66	88
Churches & Schools	75	25	0.75	92

Table 5602-3: Runoff Parameters

Land Use / Zoning	Average Percent Impervious	Average Percent Pervious	Rational Method "C"	SCS Curve Number
Industrial				
Light Areas	60	40	0.66	88
Heavy Areas	80	20	0.78	93
Parks, Cemeteries	10	90	0.36	76
Railroad Yard Areas	25	75	0.45	80
Undeveloped Areas	0	100	0.30	74
All Surfaces				
Impervious: Asphalt, Concrete, Roofs, etc.	100	0	0.90	98
Turfed	0	100	0.30	74
Wet Detention Basins	100	0	0.90	98

- C. Rational Method "C" for Non-Standard Land Use/Zoning Classifications:** The "C" value can be calculated from any type of land use and known percent impervious surface from the following equation:

$$C = 0.3 + 0.6 \cdot I$$

Where:

I = percent impervious divided by 100

- D. Un-zoned, but Master Planned Areas:** Areas whose future land use is defined by an adopted land use plan shall be assigned runoff coefficients for the land use indicated on such plan.
- E. Agricultural and Unplanned Areas**
- Existing Conditions:** For purposes of determination of development impact, undeveloped areas whose current land use is agriculture (crops, pasture, meadow) shall be assigned a maximum of 0% impervious surface or a maximum Curve Number equivalent to good condition pasture, grassland or range (C=0.30, CN=74).
 - Proposed Conditions:** Undeveloped areas designated as agricultural or those areas for which no specific land use is indicated shall be assigned a minimum of 35% impervious surface for purposes of the design of storm drainage systems (C=0.51, CN = 82).
- F. Composite Coefficients:** As an alternative to the above coefficients and for areas not listed above (office parks, shopping centers, trailer parks, etc.), a composite runoff coefficient based on the actual percentages of pervious and impervious surfaces shall be used.

5602.4 Rainfall Mass

The U.S. Soil Conservation Service (SCS) Type 2 twenty-four hour rainfall distribution shall be used for all computations that employ the use of rainfall mass. That rainfall distribution is reproduced in Table 5602-4.

Table 5602-4: Rainfall Mass

Time in Hours	Accumulated Rainfall in Percent of 24-hour Rainfall
0.0	0.00
2.0	2.20
4.0	4.80
6.0	8.00
8.0	12.00
9.0	14.70
9.5	16.30
10.0	18.10
10.5	20.40
11.0	23.50
11.5	28.30
11.75	38.70
12.0	66.30
12.5	73.50
13.0	77.20
13.5	79.90
14.0	82.00
16.0	88.00
20.0	95.20
24.0	100.00

5602.5 Unit Hydrographs

The SCS Dimensionless Unit Hydrograph (either curvilinear or triangular) shall be the basis for computation of runoff hydrographs.

5602.6 Rainfall Intensity

Rainfall intensity shall be determined from Figure 5602-1 or Table 5602-5 using a calculated Time of Concentration.

Table 5602-5: Design Aide for Calculating Rainfall Intensity Kansas City Metropolitan Area

Return Period	Equation 1 $5 \leq T_c \leq 15$	Equation 2 $15 < T_c \leq 60$
2 yr.	$i = \frac{119}{T_c + 17}$	$i = \frac{134}{T_c + 21.4}$
5 yr.	$i = \frac{154}{T_c + 18.8}$	$i = \frac{182}{T_c + 25}$

Table 5602-5: Design Aide for Calculating Rainfall Intensity Kansas City Metropolitan Area

Return Period	Equation 1	Equation 2
	$5 \leq T_c \leq 15$	$15 < T_c \leq 60$
10 yr.	$i = \frac{175}{T_c + 18.8}$	$i = \frac{214}{T_c + 26.7}$
25 yr.	$i = \frac{203}{T_c + 18.8}$	$i = \frac{262}{T_c + 28.8}$
50 yr.	$i = \frac{233}{T_c + 19.8}$	$i = \frac{296}{T_c + 29.6}$
100 yr.	$i = \frac{256}{T_c + 19.8}$	$i = \frac{331}{T_c + 30}$

5602.7 Time of Concentration and Lag Time

Time of Concentration (T_c) is equal to the overland flow time to the most upstream inlet or other point of entry to the system, Inlet Time (T_I), plus the time for flow in the system to travel to the point under consideration, Travel Time (T_T).

$$T_c = T_I + T_T$$

- A. Inlet Time:** T_I shall be calculated by the following formula or determined graphically from Figure 5602-2, but shall not be less than 5.0 minutes nor greater than 15.0 minutes:

$$T_I = 1.8 \cdot (1.1 - C) \cdot \frac{D^{1/2}}{S^{1/3}}$$

Where:

T_I = Inlet Time in minutes

C = Rational Method Runoff Coefficient as determined in accordance with paragraph 5602.3

D = Overland flow distance parallel to slope in feet (100 feet shall be the maximum distance used for overland flow)

S = Slope of tributary area surface perpendicular to contour in percent.

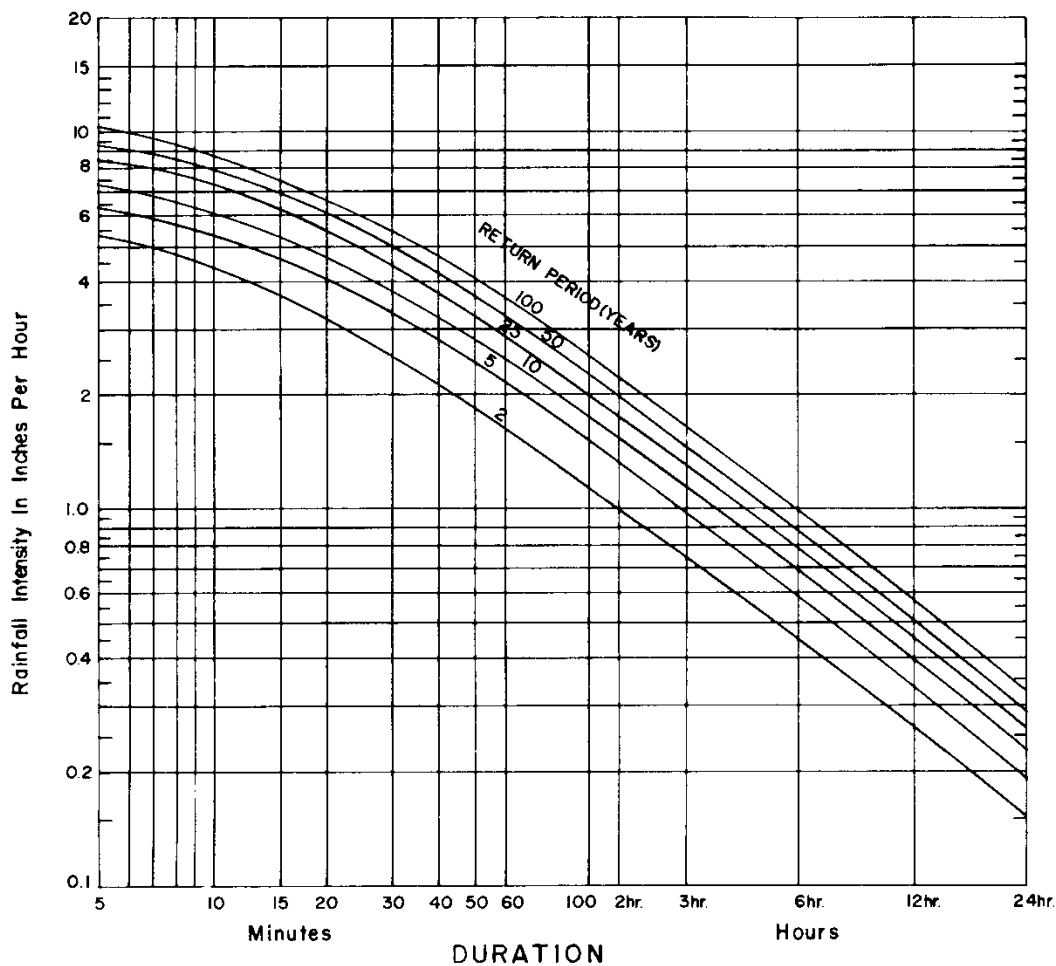

REFERENCES

1. NOAA Technical Memorandum NWS HYDRO-35 National Oceanic and Atmospheric Administration Of The National Weather Service, Department Of Commerce Silver Spring, Md., June 1977.
2. Technical Paper No. 40, Rainfall Frequency Atlas For Durations From 30 Minutes To 24 Hours And Return Periods From 1yr To 100 Yrs. U.S. Weather Bureau, Department Of Commerce, Washington, D.C., January 1963.
3. Design Of Urban Highway Drainage-State Of The Art FHWA-TS-79-225 U.S. Department Of Transportation Federal Highway Administration, Washington, D.C., August 1979.

Figure 5602-1: Intensity-Duration-Frequency (IDF) Curves for Kansas City, Missouri
(1896 to 1972)

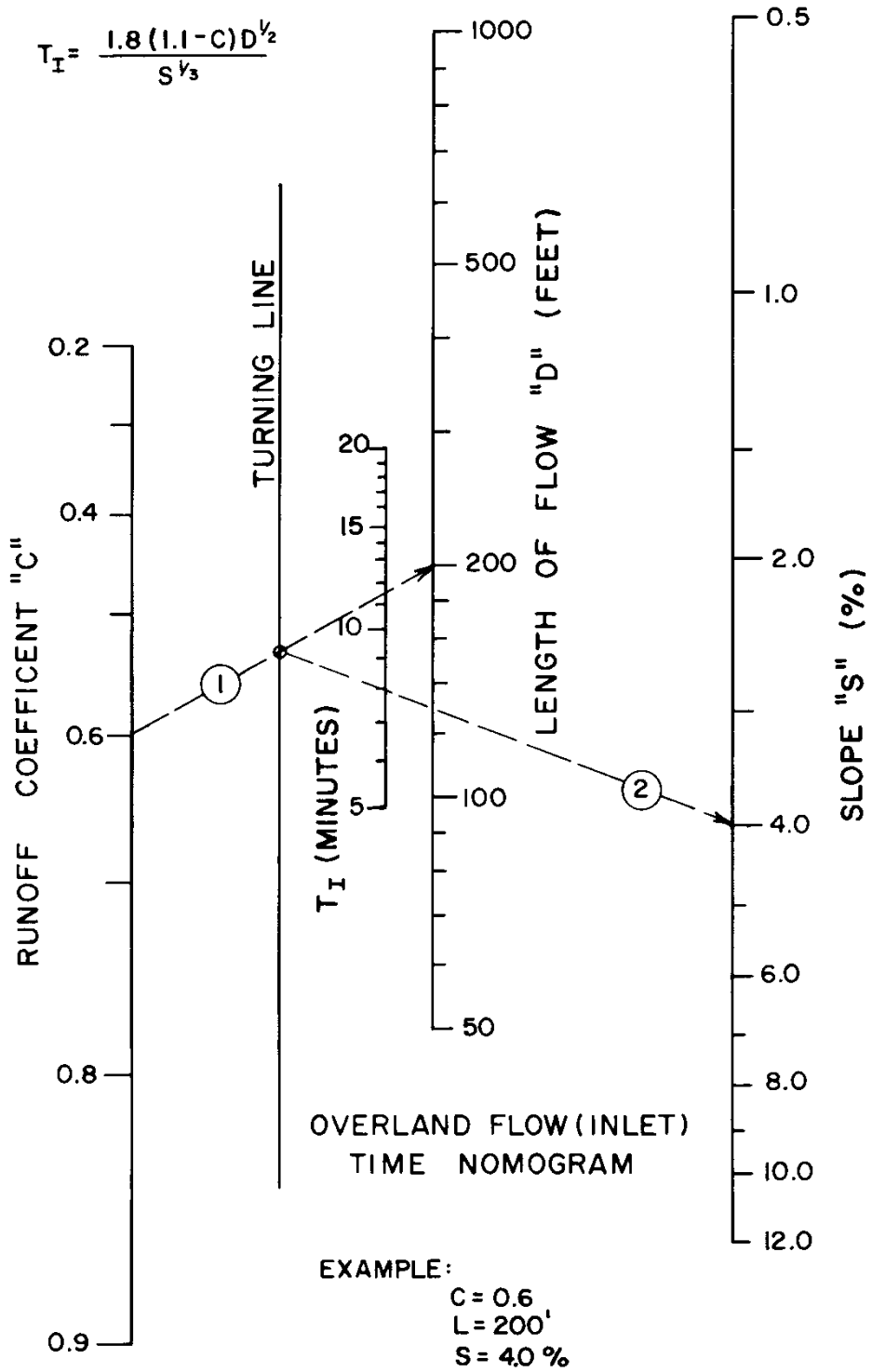
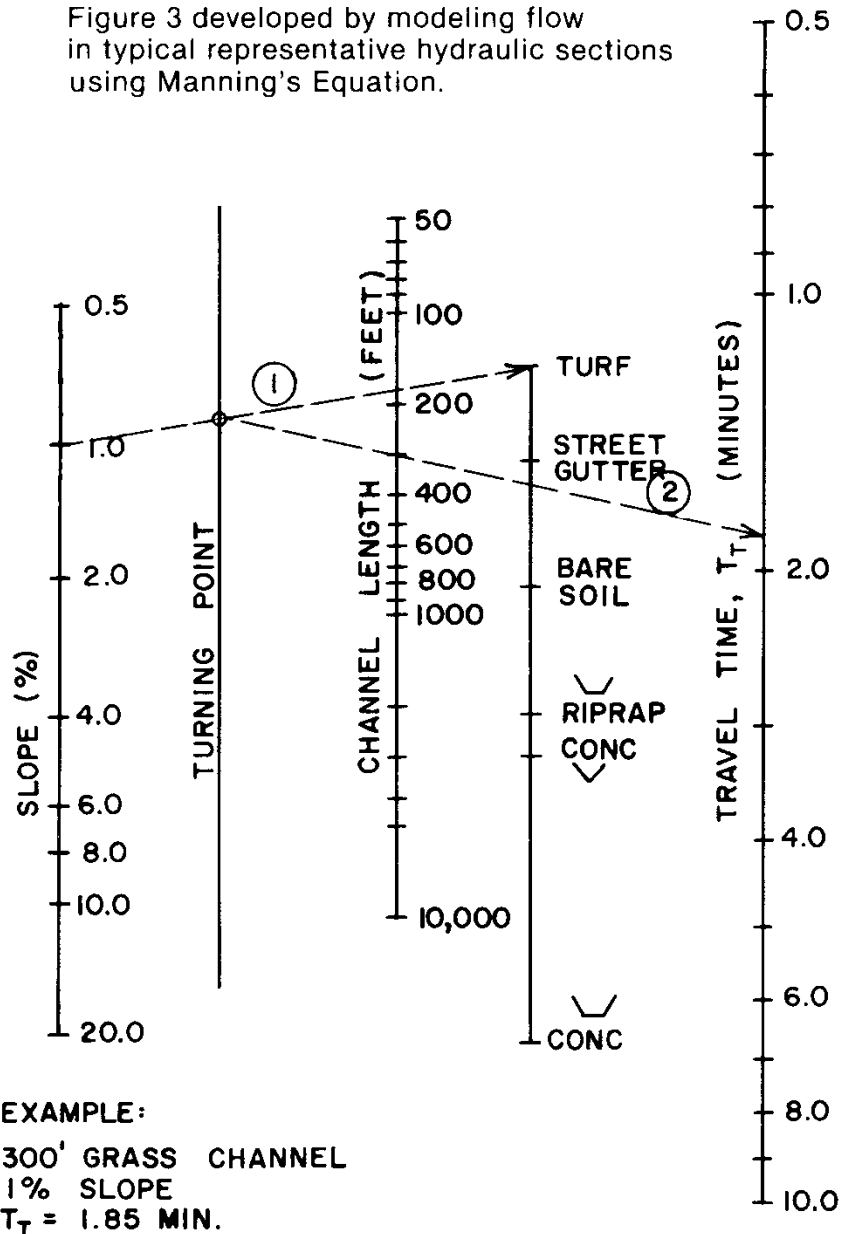

Figure 5602-2: Overland Flow (Inlet) Time Nomograph

Figure 3 developed by modeling flow in typical representative hydraulic sections using Manning's Equation.



- ① Connect Slope & Channel Condition to locate point on Turning Line
- ② Extend line from Turning Line through Channel Length, Read T_T

Figure 5602-3: Channel Flow Time Nomograph

- A. Travel Time:** T_T shall be calculated as the length of travel in the channelized system divided by the velocity of flow. Velocity shall be calculated by Manning's equation assuming all system elements are flowing full without surcharge. Travel time may be determined graphically from Figure 5602-3 in lieu of calculation.

To provide for future development when the upstream channel is unimproved, the Table 5602-6 shall be used for calculating T_T .

Table 5602-6: Travel Time Estimates for Future Development

Average Channel Slope (%)	Velocity (ft/sec)
< 2	7
2 to 5	10
> 5	15

- B. Lag Time:** Lag Time (T_L) is the calculated time between the maximum rainfall intensity of a storm and the point of maximum discharge on the outlet hydrograph. Lag Time is used instead of time of concentration for unit hydrograph models. It shall be calculated as $3/5^{\text{th}}$ the time of concentration (T_c) given by paragraph 5602.7 (A and B).

5602.8 Hydrograph Routing

Routing of hydrographs through storage elements or reservoirs shall be by modified- Puls level pool routing. Routing through channels shall be by the Muskingum-Cunge method. If the detention effect of significant storage in channels behind roadway embankments or culverts is to be modeled, the area impacted by the storage shall be modeled as a reservoir, and the remainder of the channel modeled using Muskingum- Cunge. Such incidental detention shall not be used for design discharge estimates unless allowed by the City/County and it can be reliably demonstrated that such storage will be maintained over the useful life of the proposed improvements.

5602.9 Calibration and Model Verification

All design discharge estimates should be calibrated to the extent possible using reliable gauge data, high water marks, or historical accounts. Model results should be evaluated to verify that they are reasonably conservative as compared to observed data and standard practice. Model calibration shall not be used to justify discharge estimates that are lower than those provided by the baseline unit hydrograph method, unless unusual site specific factors justify, where the hydrologic impact of such factors must be thoroughly examined and documented. Engineers shall recognize the significant uncertainty associated with design discharge estimates and provide estimates that are reasonably conservative and protective of the public interest. To permit model verification, discharge rates (expressed as absolute discharge or discharge per acre of tributary area) shall be plotted relative to tributary area and compared to regression formula results, gauge estimates, and/or known historical extremes.

Figure 5602-4: 100-year Discharge per Kansas Rural Regression Formula (2000) and Gage Estimates

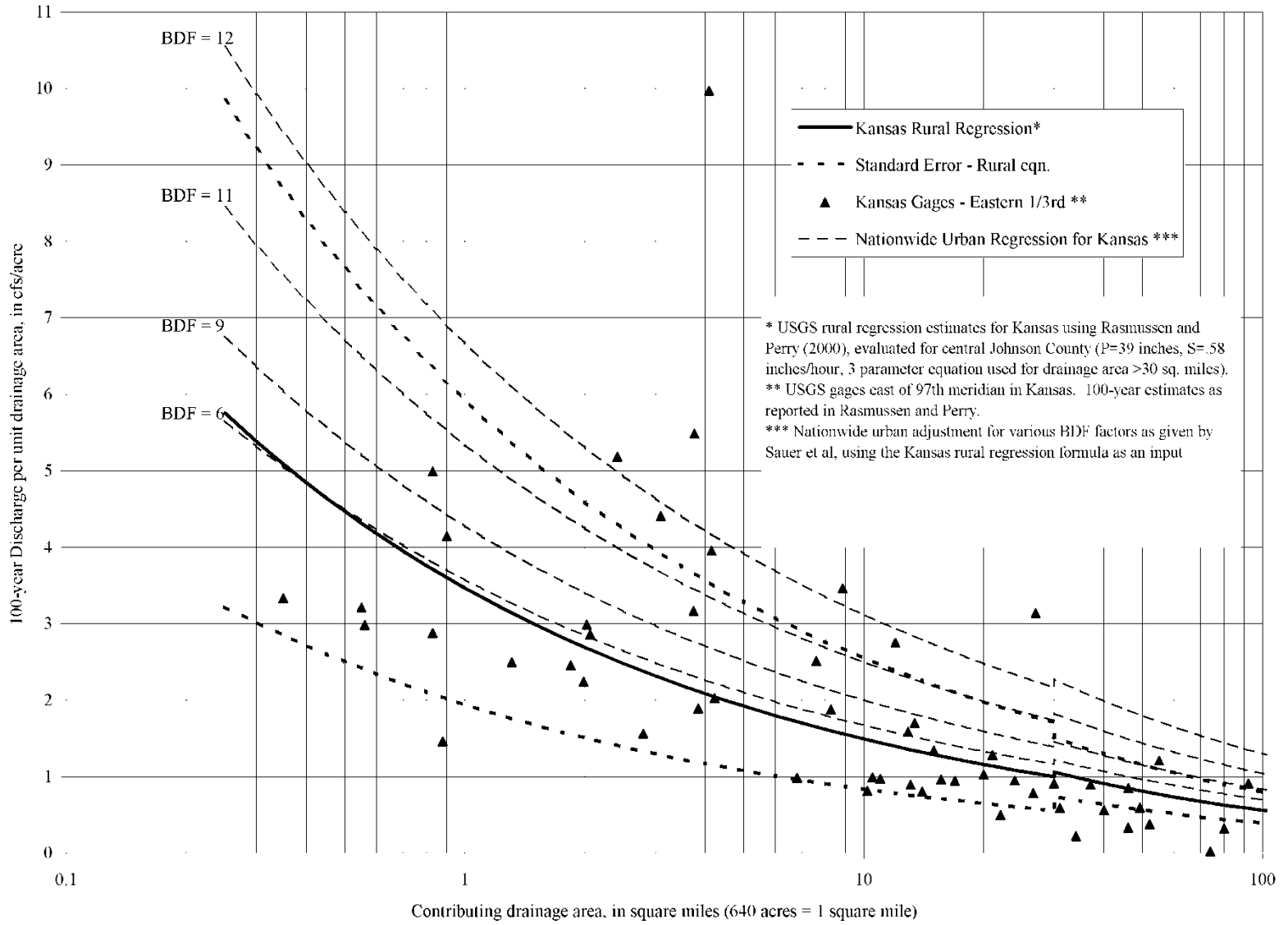

Figure 5602-5: 100-year Discharge per Missouri Rural Regression Formula and Gage Estimates

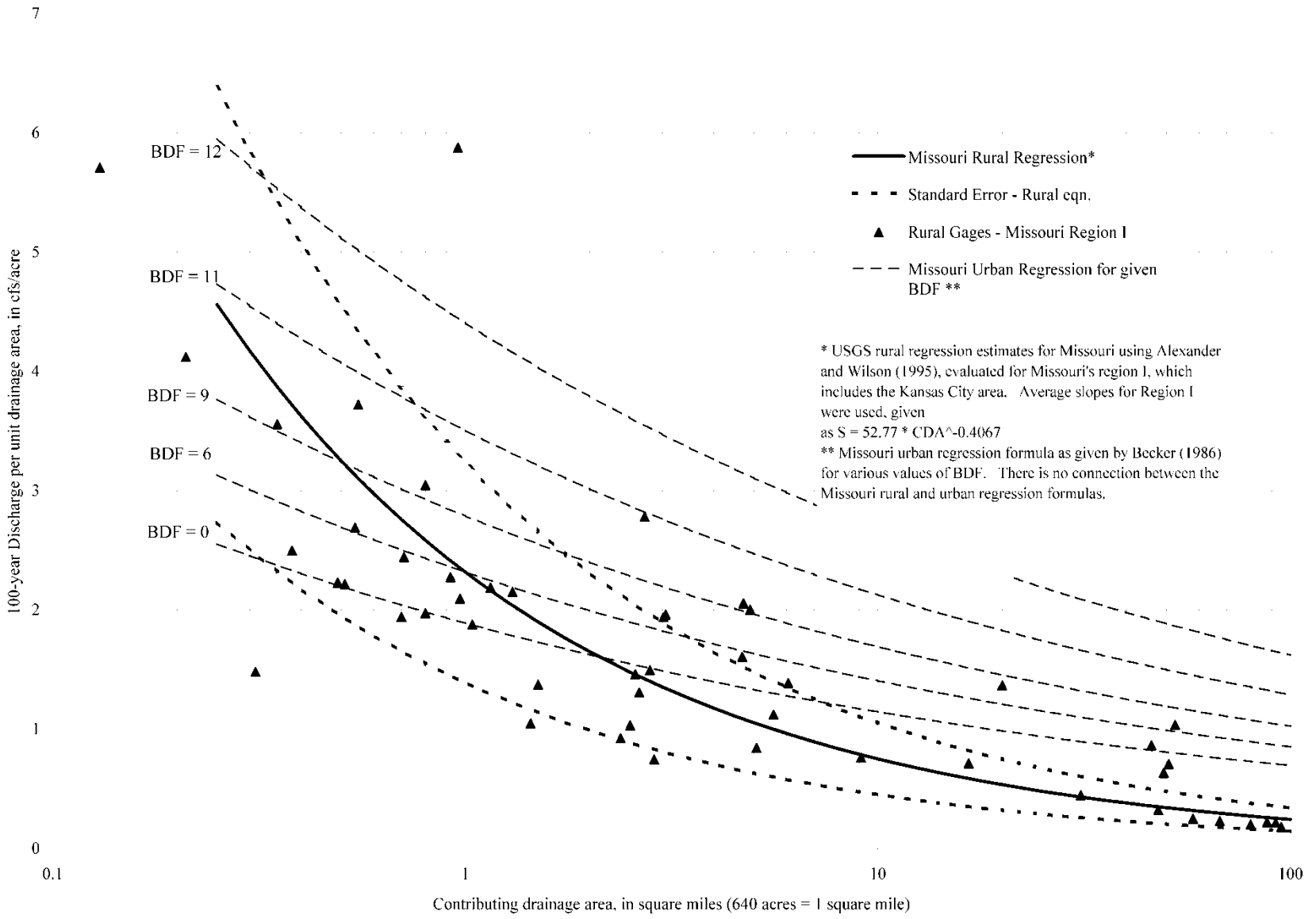

Figure 5602-6: Documented Extreme Streamflows (no return period estimates) in Kansas City and the Region, as Discharges per Unit Drainage Area

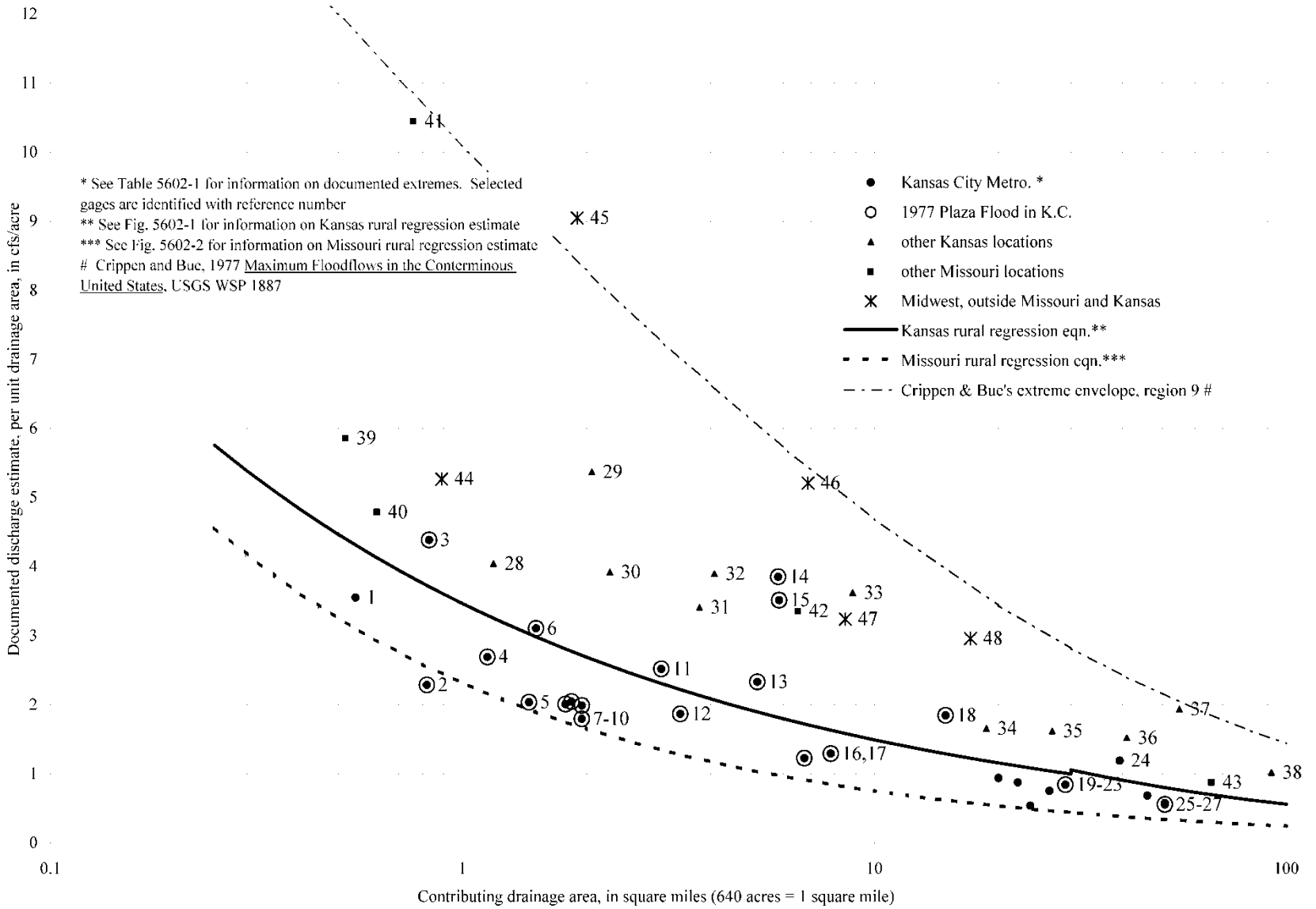
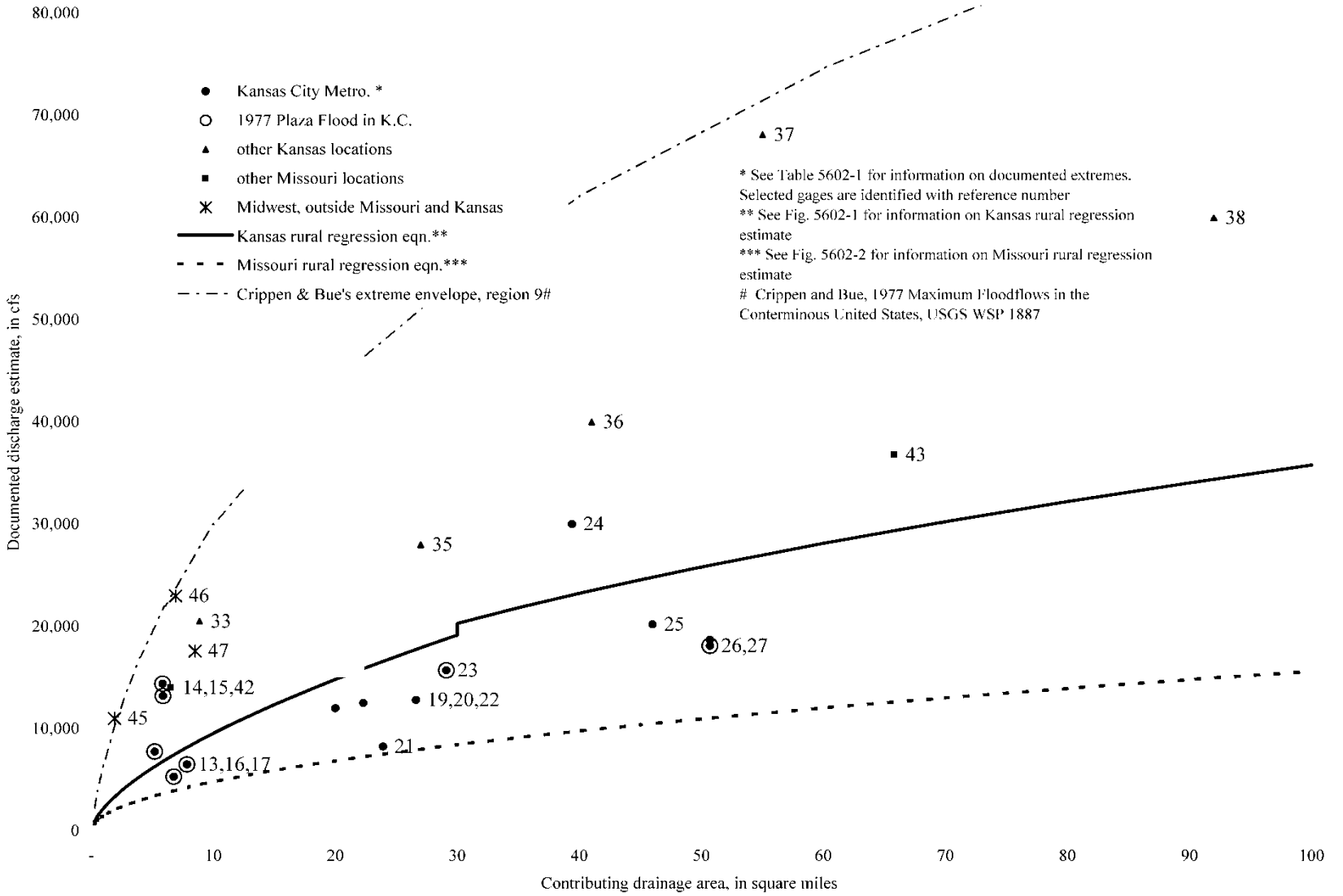

Figure 5602-7: Documented Extreme Streamflows (no return period estimated) in Kansas City and the Region, as Absolute Discharges



SECTION 5603 HYDRAULICS

5603.1 Hydraulic Calculations for Pipes, Culverts, and Open Channels

- A. Gravity versus Pressure Flow for Enclosed Systems:** Two design philosophies exist for sizing storm drains under the steady uniform flow assumption. The first is referred to as open channel, or gravity flow design, in which the water surface within the conduit remains open to atmospheric pressure. Pressure flow design, on the other hand, requires that the flow in the conduit be at a pressure greater than atmospheric. For a given flow rate, design based on open channel flow requires larger conduit sizes than those sized based on pressure flow. While it may be more expensive to construct storm drainage systems designed based on open channel flow, this design procedure provides a margin of safety by providing additional headroom in the conduit to accommodate an increase in flow above the design discharge. Under most ordinary conditions, it is recommended that storm drains be sized based on a gravity flow criteria at full flow or near full. Pressure flow design may be justified in certain instances. As hydraulic calculations are performed, frequent verification of the existence of the desired flow condition should be made.

Storm drainage systems can often alternate between pressure and open channel flow conditions from one section to another (U.S. Department of Transportation Federal Highway Administration, 1996).

For gravity flow conditions, Manning's formula shall be used as described below.

$$Q = \frac{1.486}{n} A R^{2/3} S^{1/2}$$

Where:

Q = Discharge, cubic feet per second

A = Cross sectional area of flow, square feet

n = Manning's roughness coefficient (see Table 5603-1)

R = Hydraulic radius, feet

$$R = \frac{A}{P}$$

S = Slope in feet per foot

P = Wetted perimeter in feet

In closed conduits flowing under pressure flow, the energy grade line (EGL) will be above the crown of the pipe. In this case, the Bernoulli equation shall be used to calculate pipe capacity:

$$\frac{p_1}{\gamma} + \frac{V_1^2}{2g} + z_1 = \frac{p_2}{\gamma} + \frac{V_2^2}{2g} + z_2 + h_f + h_m$$

Where:

$\frac{p_1}{\gamma}$ = pressure head in the upstream system segment, feet

$\frac{V_1^2}{2g}$ = velocity head in the upstream system segment, feet

z_1 = elevation of the system invert in the upstream system segment, feet

$\frac{p_2}{\gamma}$ = pressure head in the upstream system segment, feet

$\frac{V_2^2}{2g}$ = velocity head in the upstream system segment, feet

z_2 = elevation of the system invert in the upstream system segment, feet

h_f = friction loss in the downstream system segment in feet

h_m = minor system losses in the downstream segment in feet

Pipe friction losses, h_f , may be calculated the friction slope method.

B. Friction Slope Method

This derivation of Manning's equation is from (FHWA, 1996).

$$h_f = S_f L$$

$$S_f = \frac{(Q \cdot n)^2}{\left(1.486 A \cdot R^{\frac{2}{3}}\right)^2}$$

S_f = friction slope, feet/foot (which is also the slope of the HGL)

Minor losses, h_m , shall be calculated by:

$$h_m = k \cdot \frac{v^2}{2g}$$

Where:

k = Coefficient as shown in Table 5603-2

A step-by-step procedure for manual calculation of the EGL using the energy loss method is presented in Section 7.5 of (FHWA, 1996). For most drainage systems, computer methods such as HYDRA, StormCAD, CulvertMaster, or SWMM are the most efficient means of evaluating the EGL and designing the system elements.

Table 5603-1: Manning's Roughness Coefficient

Type of Channel	n
Closed Conduits	
Reinforced Concrete Pipe (RCPs)	0.013
Reinforced Concrete Elliptical Pipe	0.013
Corrugated Metal Pipe (CMPs):	
2 $\frac{2}{3}$ x $\frac{1}{2}$ in. Annular or Helical Corrugations unpaved - plain	0.024
2 $\frac{2}{3}$ x $\frac{1}{2}$ in. Annular or Helical Corrugations paved invert	0.021
3x1 in. Annular or Helical Corrugations unpaved - plain	0.027
3x1 in. Annular or Helical Corrugations paved invert	0.023
6x2 in. Corrugations unpaved - plain	0.033
6x2 in. Corrugations paved invert	0.028
24" diameter and smaller with Helical Corrugations.*	0.020
Vitrified Clay Pipe	0.013
Asbestos Cement Pipe	0.012
Open Channels (Lined)	
Gabions	0.025
Concrete	
Trowel Finish	0.013

Table 5603-1: Manning's Roughness Coefficient

Type of Channel	n
Float Finish	0.015
Unfinished	0.017
Concrete, bottom float finished, with sides of	
Dressed Stone	0.017
Random Stone	0.020
Cement Rubble masonry	0.025
Dry Rubble or Riprap	0.030
Gravel bottom, side of	
Random Stone	0.023
Riprap	0.033
Grass (Sod)	0.030
Riprap	0.035
Grouted Riprap	0.030
Open Channels (Unlined) Excavated or Dredged	
Earth, straight and uniform	0.027
Earth, winding and sluggish	0.035
Channels, not maintained, weeds & brush uncut	0.090
Natural Stream	
Clean stream, straight	0.030
Stream with pools, sluggish reaches, heavy underbrush	0.100
Flood Plains	
Grass, no brush	0.030
With some brush	0.090
Street Curbing	0.014

*Allowed only when the pipe length between structures is at least 20 pipe diameters.

Table 5603-2: Head Loss Coefficients

Condition	k
Manhole, junction boxes and inlets with shaped inverts:	
Thru flow	0.15
Junction	0.40
Contraction transition	0.10
Expansion transition	0.20
90 degree bend	0.40
45 degree and less bends	0.30
Culvert Inlets:	
Pipe, Concrete	
Projecting from fill, socket end (grove end)	0.20

Table 5603-2: Head Loss Coefficients

Condition	k
Projecting from fill, sq. cut end	0.50
Headwall or headwall and wingwalls	
Socket end of pipe (groove end)	0.20
Square edge	0.50
Round (radius=1/12D)	0.20
Mitered to conform to fill slope	0.70
Standard end section	0.50
Beveled edges, 33.7° or 45° bevels	0.20
Side or slope-tapered inlet	0.20
Pipe, or Pipe-Arch, Corrugated Metal	
Projecting from fill (no headwall)	0.90
Headwall or headwall and wingwalls square edge	0.50
Mitered to conform to fill slope, paved or unpaved slope	0.70
Standard end section	0.50
Beveled edges, 33.7° or 45° bevels	0.20
Side or slope-tapered inlet	0.20
Box, Reinforced Concrete	
Headwall parallel to embankment (no wingwalls)	
Square edged on 3 edges	0.50
Rounded on 3 edges to radius of 1/12 barrel dim. or beveled edges on 3 sides	0.20
Wingwalls at 30° to 75° to barrel	
Square edged at crown	0.40
Crown edge rounded to radius of 1/12 barrel dimension or beveled top edge	0.20
Wingwalls at 10° to 25° to barrel - square edged at crown	0.50
Wingwalls parallel (extension of sides) - square edged at crown	0.70
Side or slope-tapered inlet	0.20

Note: When 50 percent or more of the discharge enters the structure from the surface, "k" shall be 1.0.

- C. Culverts:** Classified as having either entrance or outlet control. Either the inlet opening (entrance control), or friction loss within the culvert or backwater from the downstream system (outlet control) will control the discharge capacity.
- 1. Entrance Control:** Entrance control occurs when the culvert is hydraulically short (when the culvert is not flowing full) and steep. Flow at the entrance would be critical as the water falls over the brink. If the tailwater covers the culvert completely (i.e., a submerged exit), the culvert will be full at that point, even though the inlet control forces the culvert to be only partially full at the inlet. The transition from partially full to full occurs in a hydraulic jump, the location of which depends on the flow resistance and water levels. If the flow resistance is very high, or if the headwater and tailwater levels are high

enough, the jump will occur close to or at the entrance. Design variables for culverts operating under entrance control shall be determined from Figures 5603-1 through 5603-7.

2. **Outlet Control:** If the flow in a culvert is full for its entire length, then the flow is said to be under outlet control. The discharge will be a function of the differences in tailwater and headwater levels, as well as the flow resistance along the barrel length. Design variables for culverts operating under outlet control shall be determined from Figures 5603-8 through 5603-14.

Alternatively, refer to the Federal Highway Administration website for these charts (www.fhwa.dot.gov/bridge/hec05.pdf). Download applicable design manuals, reports, and FHWA hydraulics engineering such as Bridge Waterways Analysis Model (WSPRO), FHWA Culvert Analysis, and HDS 5 Hydraulic Design of Highway Culverts from www.fhwa.dot.gov/bridge/hydsoft.htm. These are applicable when flow in the upstream channel is subcritical.

- D. **Open Channels/Bridges:** Proper evaluation of the velocity, depth, and width of flow requires analyses of the structures and conditions that impact the flow. Boundary flow conditions upstream and downstream from the open channel system must be established. The standard-step backwater method, using the energy equation, can be used to determine the depth, velocity, and width of flow. Major stream obstructions, changes in slope, changes in cross-section, and other flow controls can cause significant energy loss. In these cases, the energy equation does not apply and the momentum equation must be used to determine the depth, velocity, and width of flow.

Hydraulic calculations for open channels may also be made by the U.S. Army Corps of Engineer's 'HEC-2 Water Surface Profiles' or 'HEC-RAS River Analysis System' computer programs. The HEC-2 program computes water surface profiles for one-dimensional steady, gradually varied flow in rivers of any cross section. HEC-RAS is an integrated system of software, designed for interactive use in a multi-tasking, multi-user network environment. The system has separate hydraulic analysis components, data storage and management capabilities, graphics and reporting facilities. The HEC-RAS system is intended for calculating water surface profiles for steady and unsteady gradually varied flow. The system can handle a full network of channels, a dendritic system, or a single river reach. Like HEC-2, HEC-RAS is capable of modeling subcritical, supercritical, and mixed flow regime water surface profiles. (www.hec.usace.army.mil).

5603.2 Analysis of Systems by Computer Models

The following list provides the commonly used computer programs for analyzing specific hydraulic systems. This is not an exhaustive list and alternates may be used with approval by the City/County Engineer.

A. Enclosed Pipe Systems in Gravity Flow

- SWMM Transport (EPA)
- HYDRA (FHWA)
- StormCad (Bentley)
- DR3M (USGS)

B. Enclosed Pipe Systems in Pressure Flow

- SWMM EXTRAN (EPA)
- MOUSE (DHI)
- HYDRA (FHWA)
- StormCad (Bentley)

C. Culverts

- HY8 (FHWA)
- WSPRO (USGS)
- CulvertMaster (Bentley)

D. Open Channels and Culverts/Bridges:

- HEC-2 (USACE)
- HEC-RAS (USACE)
- WSPRO (USGS)
- HYCHL (FHWA)
- SWMM Transport and EXTRAN (EPA)
- DR3M (USGS)

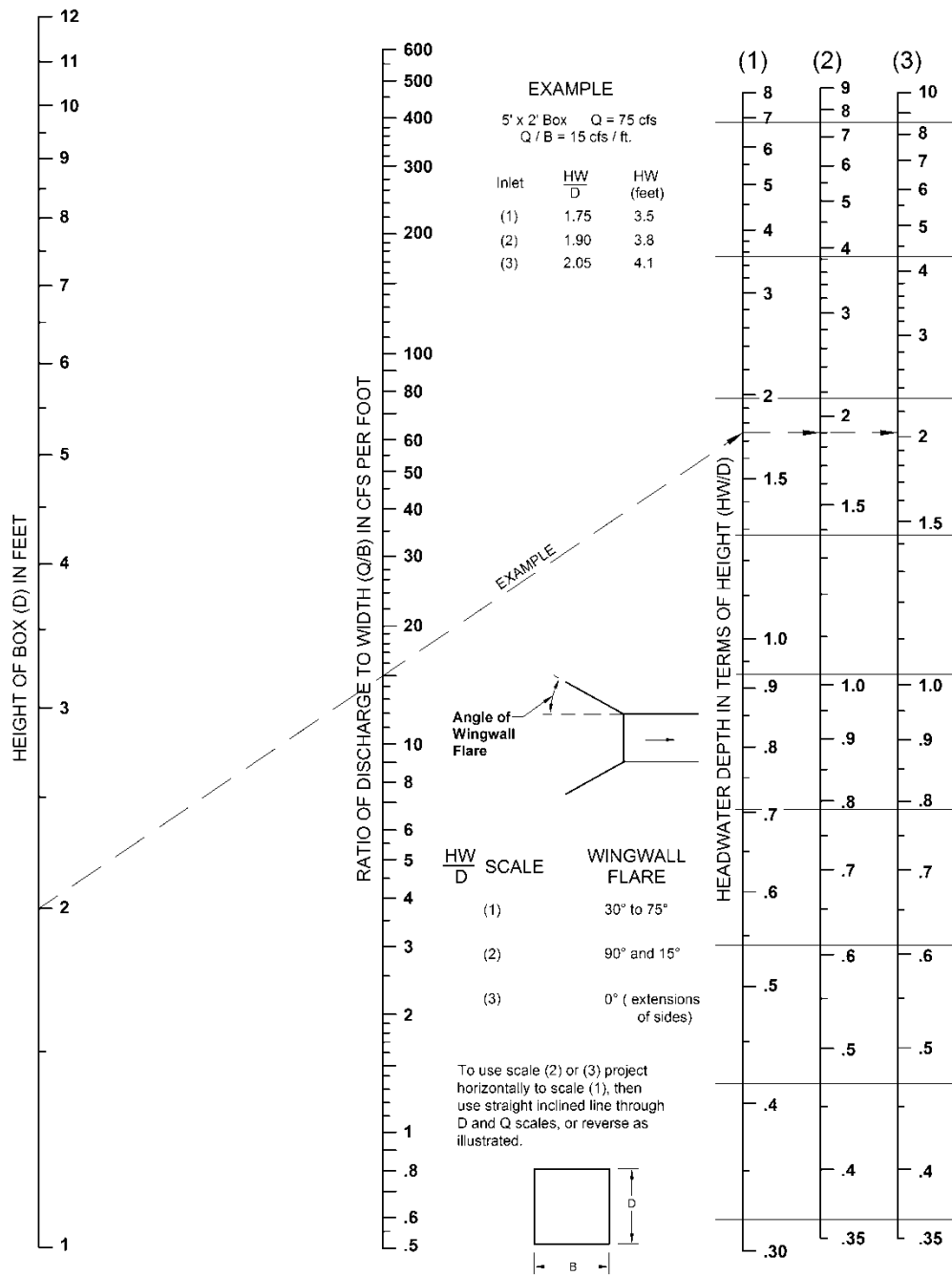

BUREAU OF PUBLIC ROADS JAN. 1963

Figure 5603-1: Headwater Depth for Box Culverts with Inlet Control

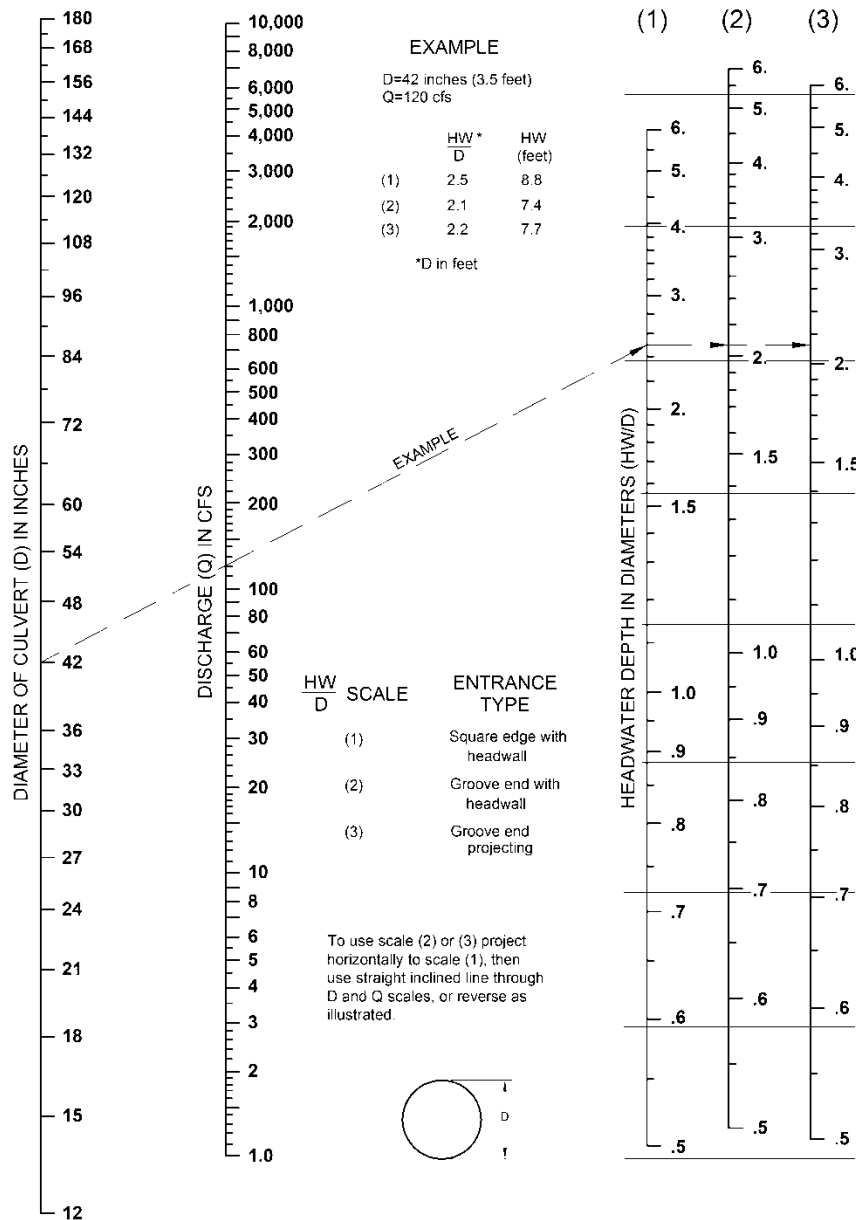

BUREAU OF PUBLIC ROADS JAN. 1963
 HEADWATER SCALES 2 & 3 REVISED MAY 1964

Figure 5603-2: Headwater Depth for Concrete Pipe Culverts with Inlet Control

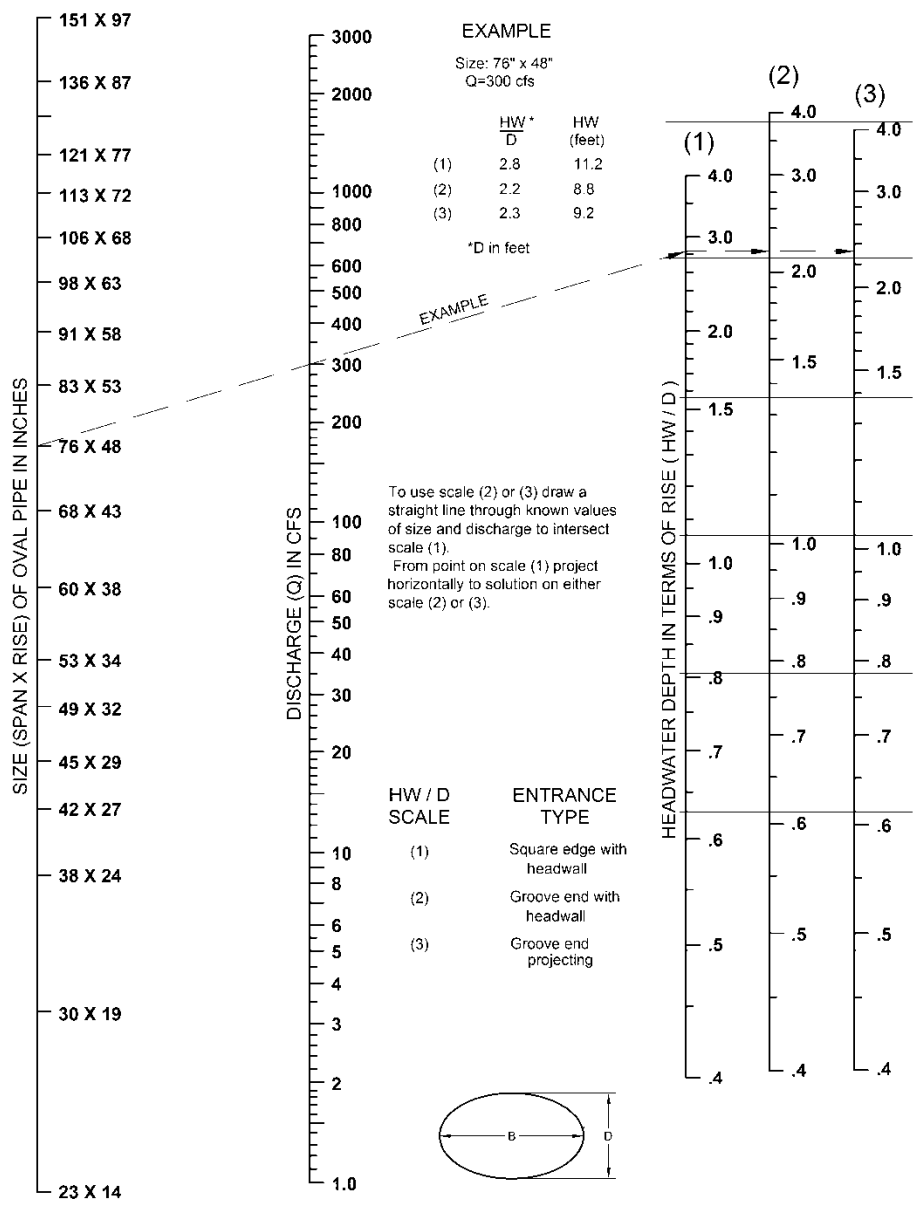

BUREAU OF PUBLIC ROADS JAN. 1963

Figure 5603-3: Headwater Depth for Oval Concrete Pipe Culverts, Long Axis Horizontal with Inlet Control

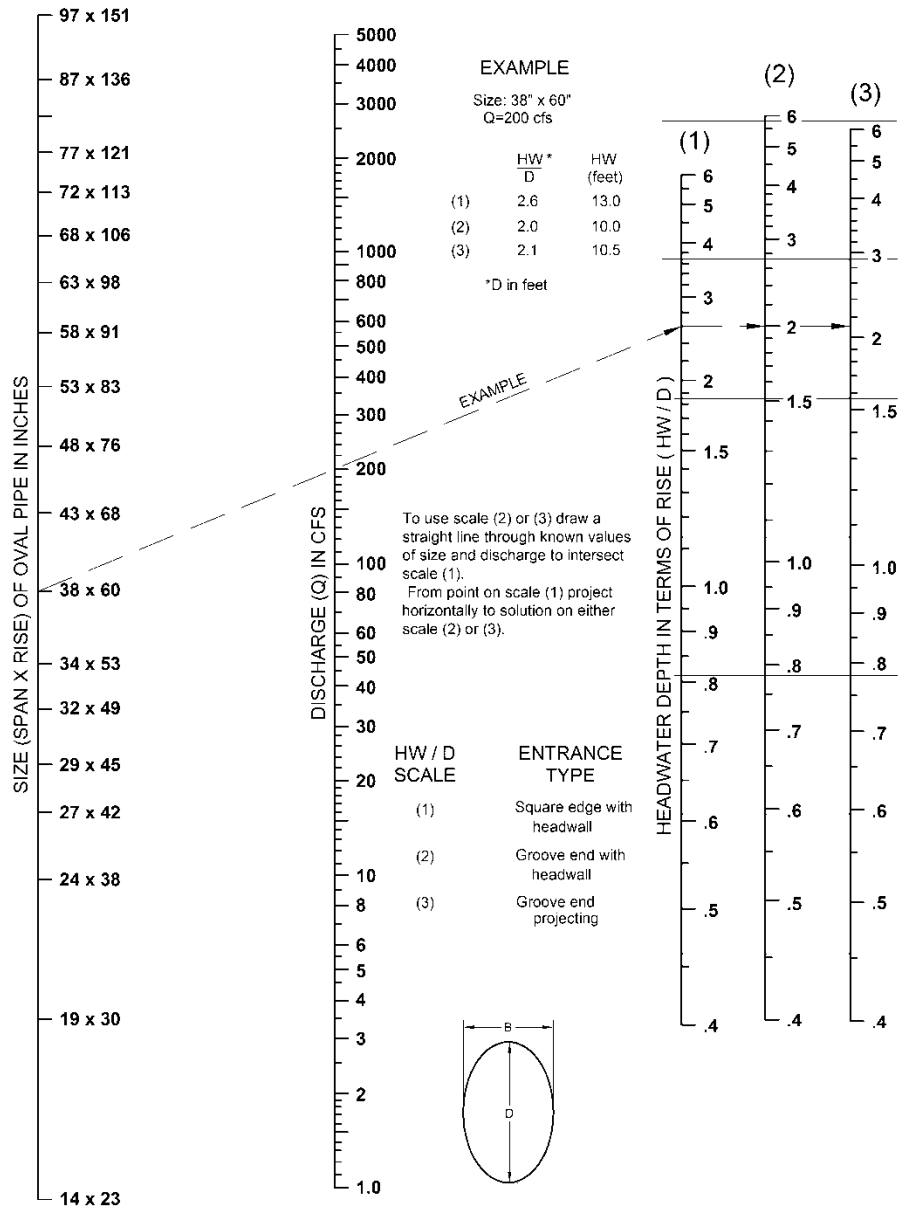

BUREAU OF PUBLIC ROADS JAN. 1963

Figure 5603-4: Headwater Depth for Oval Concrete Pipe Culverts, Long Axis Vertical with Inlet Control

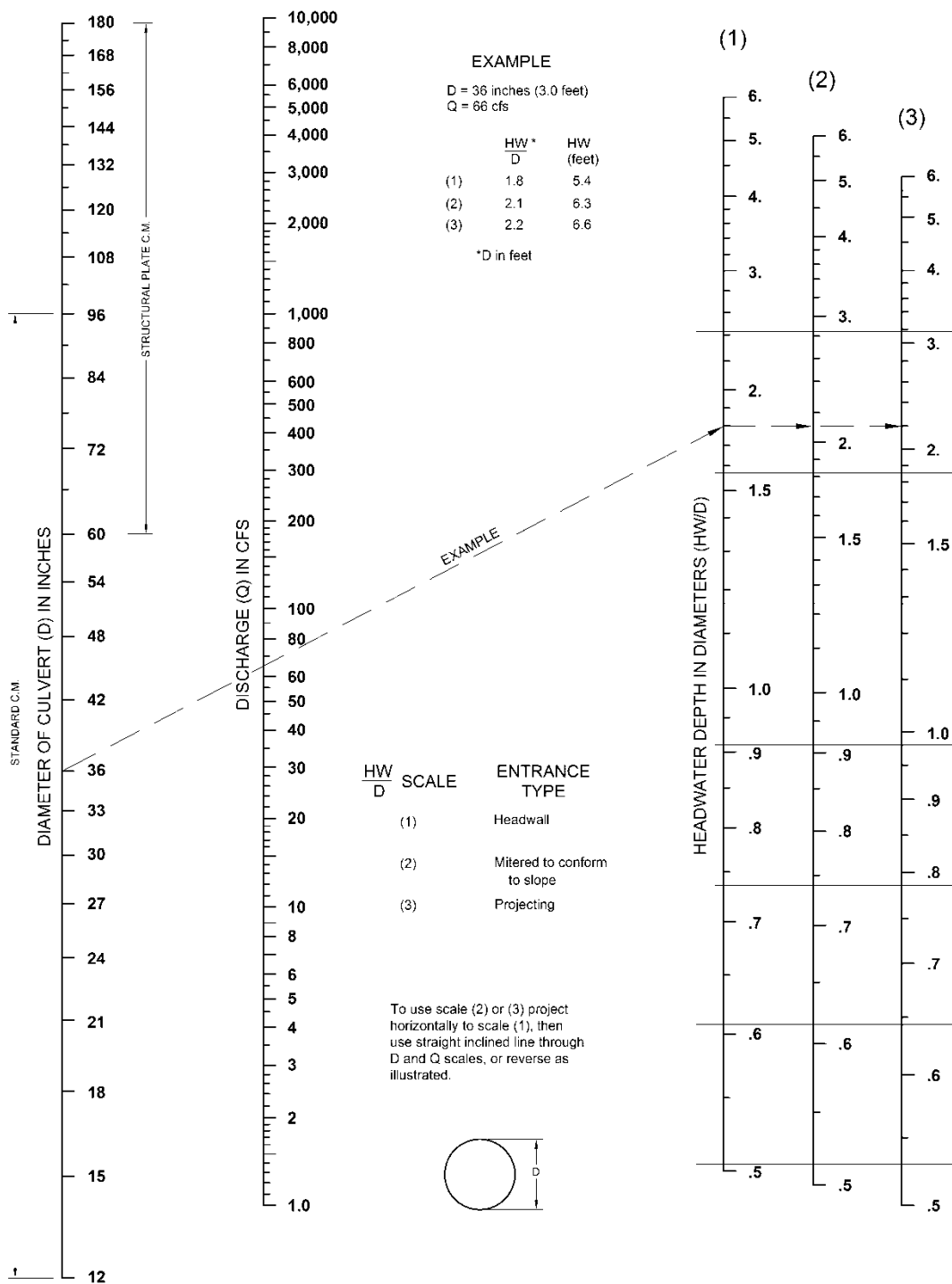

BUREAU OF PUBLIC ROADS JAN. 1963

Figure 5603-5: Headwater Depth for Corrugated Metal Pipe Culverts with Inlet Control

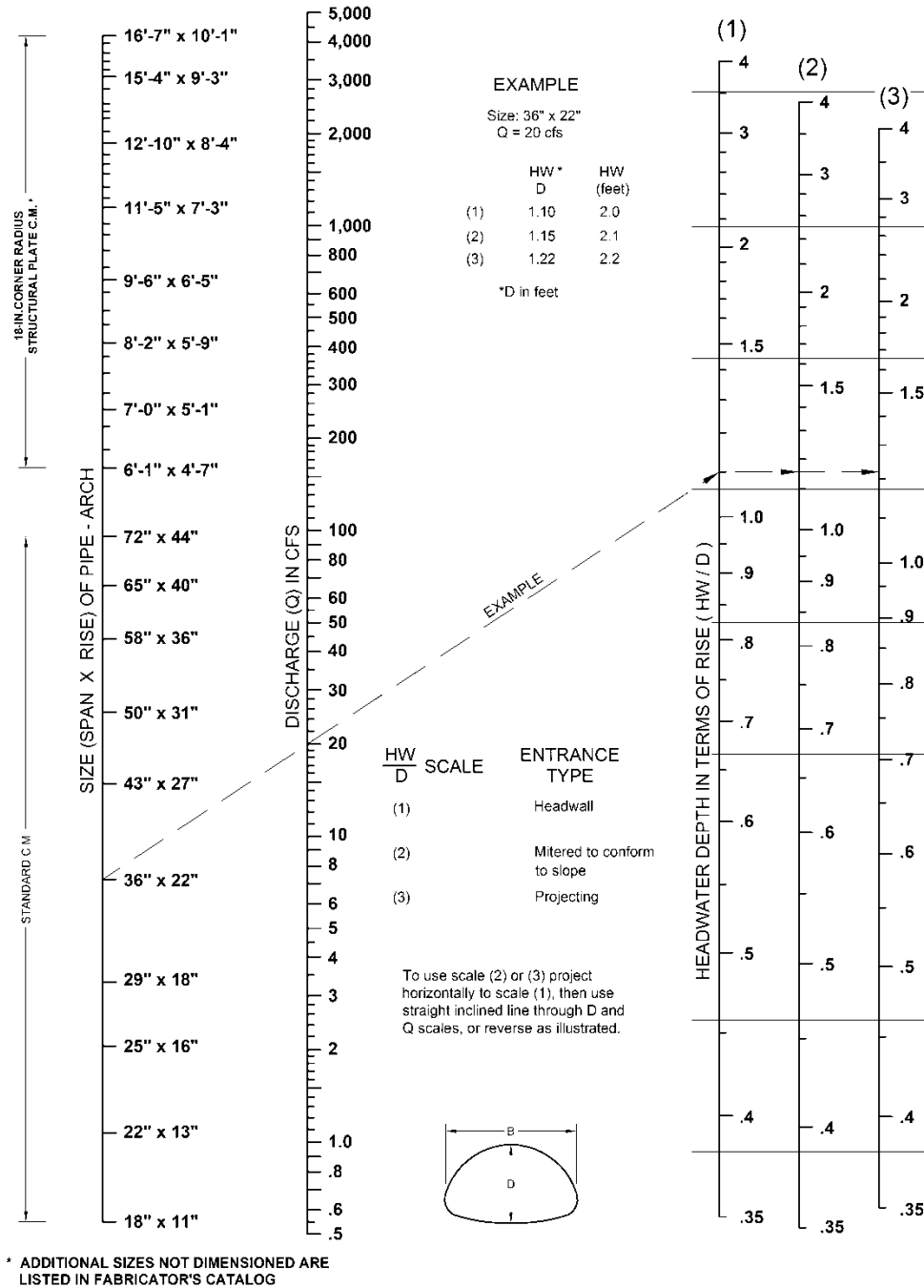

* ADDITIONAL SIZES NOT DIMENSIONED ARE LISTED IN FABRICATOR'S CATALOG

BUREAU OF PUBLIC ROADS, JAN. 1963

Figure 5603-6: Headwater Depth for Corrugate Metal Pipe – Arch Culvert with Inlet Control

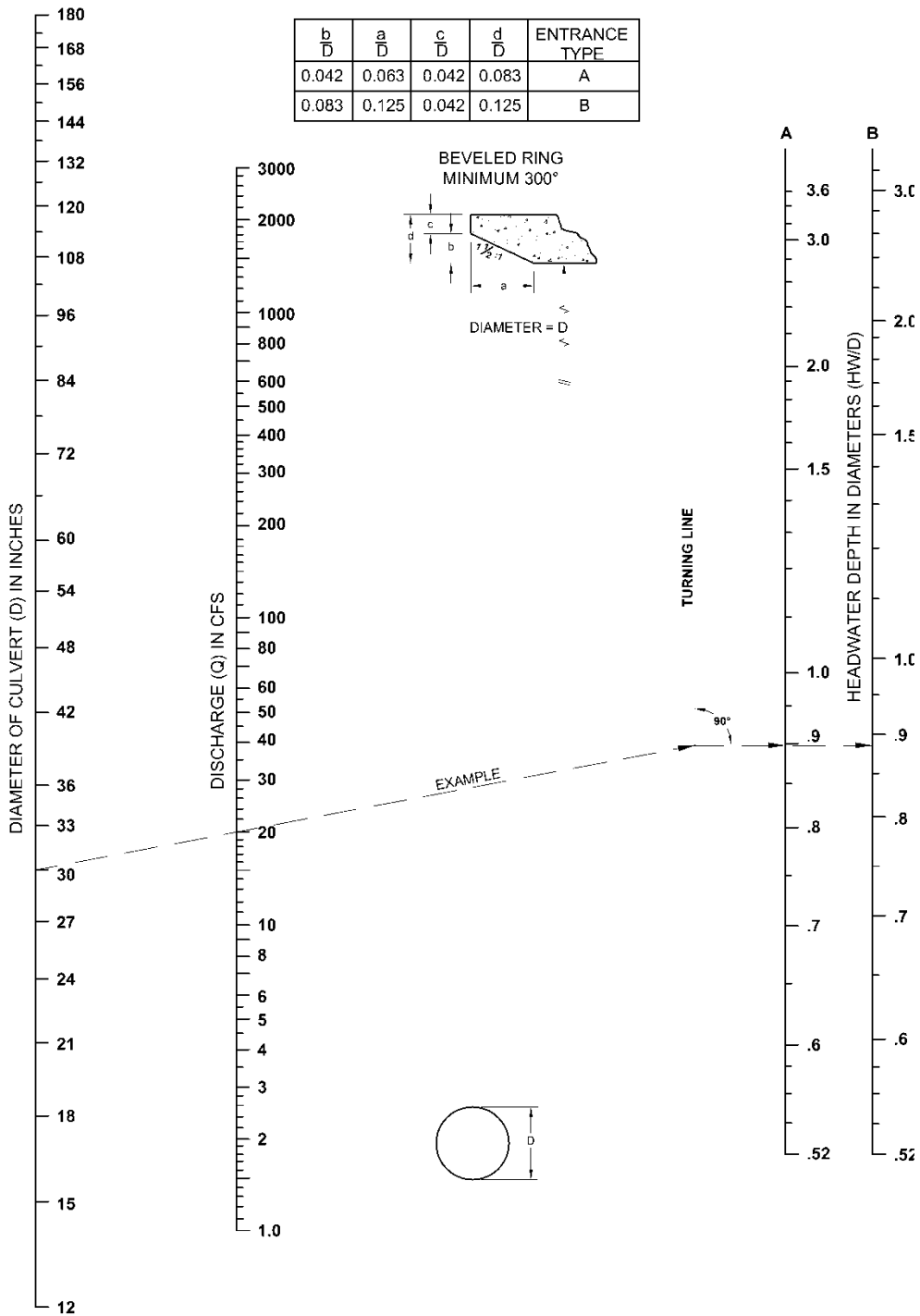

FEDERAL HIGHWAY ADMINISTRATION
MAY 1973

Figure 5603-7: Headwater Depth for Circular Pipe Culverts with Beveled Ring Inlet Control

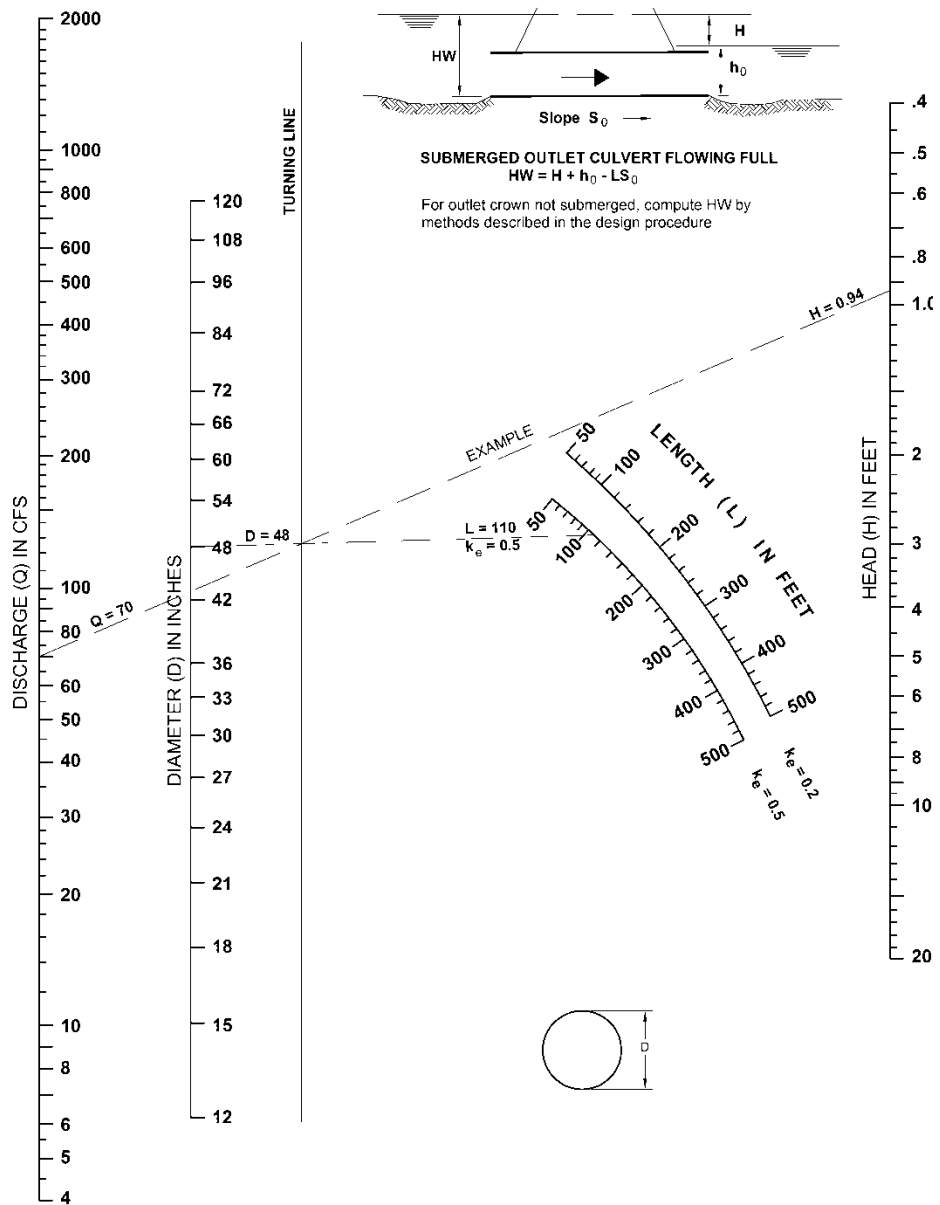

BUREAU OF PUBLIC ROADS, JAN. 1963

Figure 5603-8: Head for Concrete Pipe Culverts Flowing Full (n=0.12)

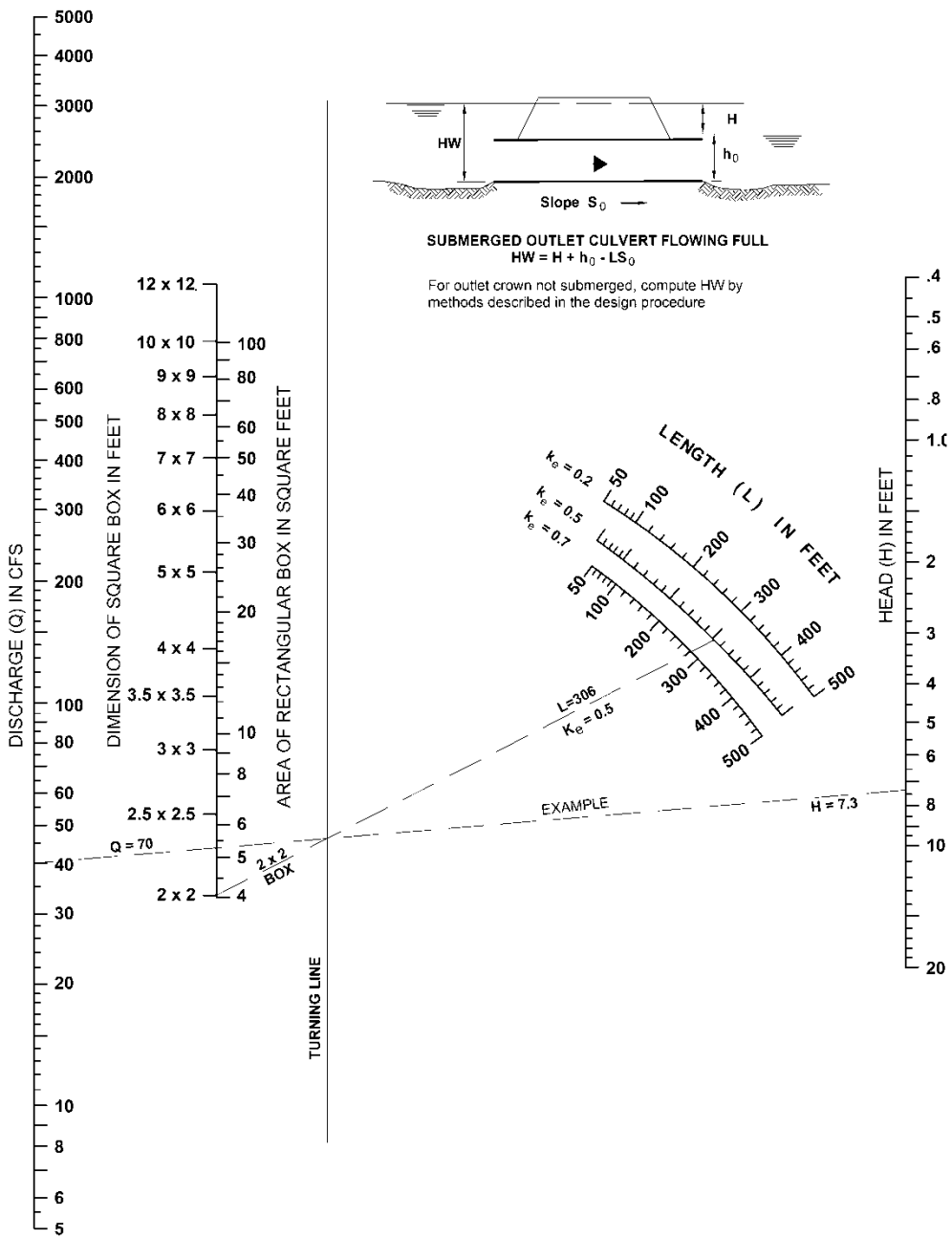

BUREAU OF PUBLIC ROADS, JAN. 1963

Figure 5603-9: Head for Concrete Box Culverts Flowing Full (n=0.012)

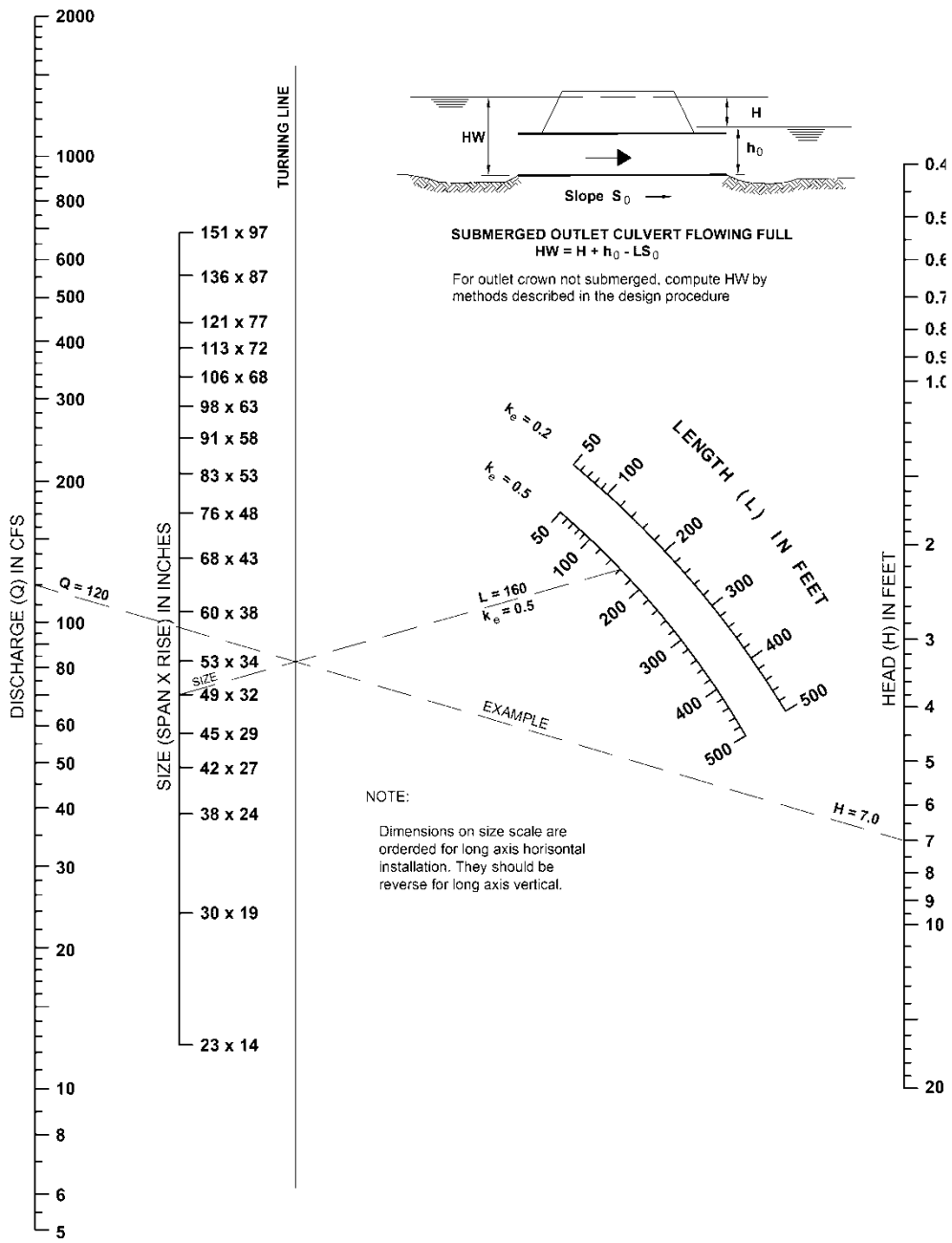

BUREAU OF PUBLIC ROADS JAN. 1963

Figure 5603-10: Head for Oval Concrete Pipe Culverts, Long Axis Horizontal or Vertical Flowing Full (n=0.12)

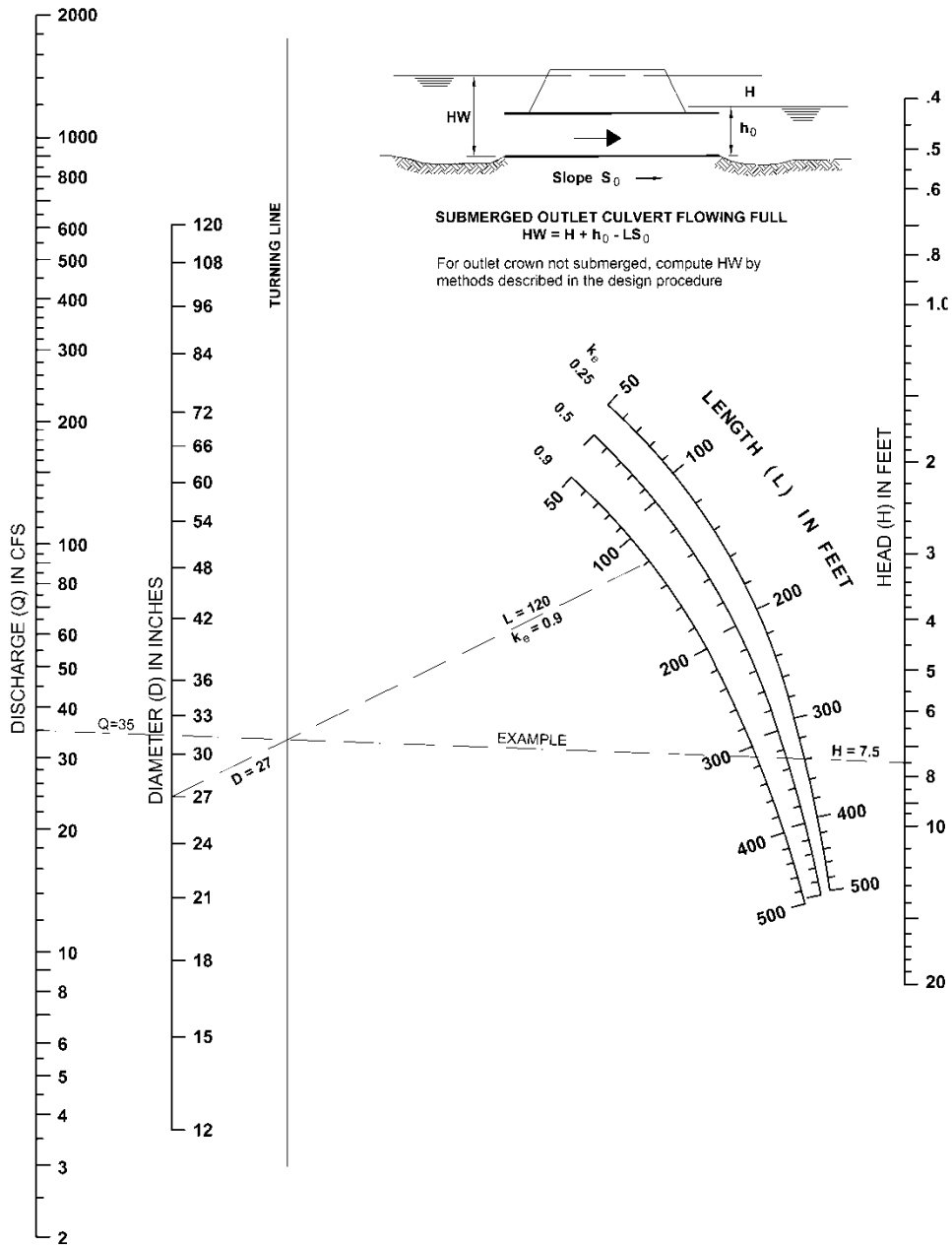

BUREAU OF PUBLIC ROADS JAN. 1963

Figure 5603-11: Head for Standard Corrugate Metal Pipe Culverts Flowing Full ($n=0.024$)

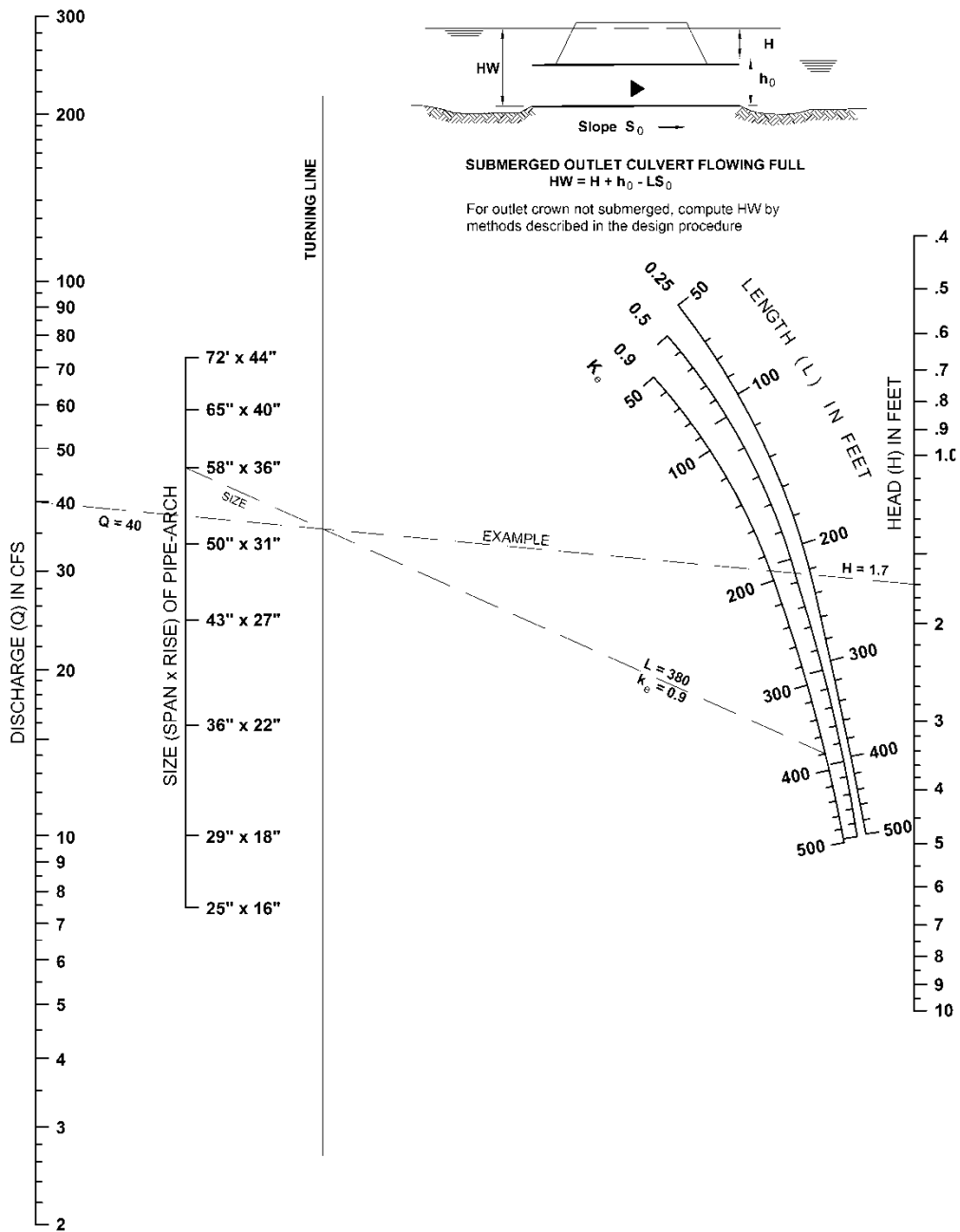

BUREAU OF PUBLIC ROADS, JAN. 1963

Figure 5603-12: Head for Standard Corrugated Metal Pipe-Arch Culverts Flowing Full (n=0.024)

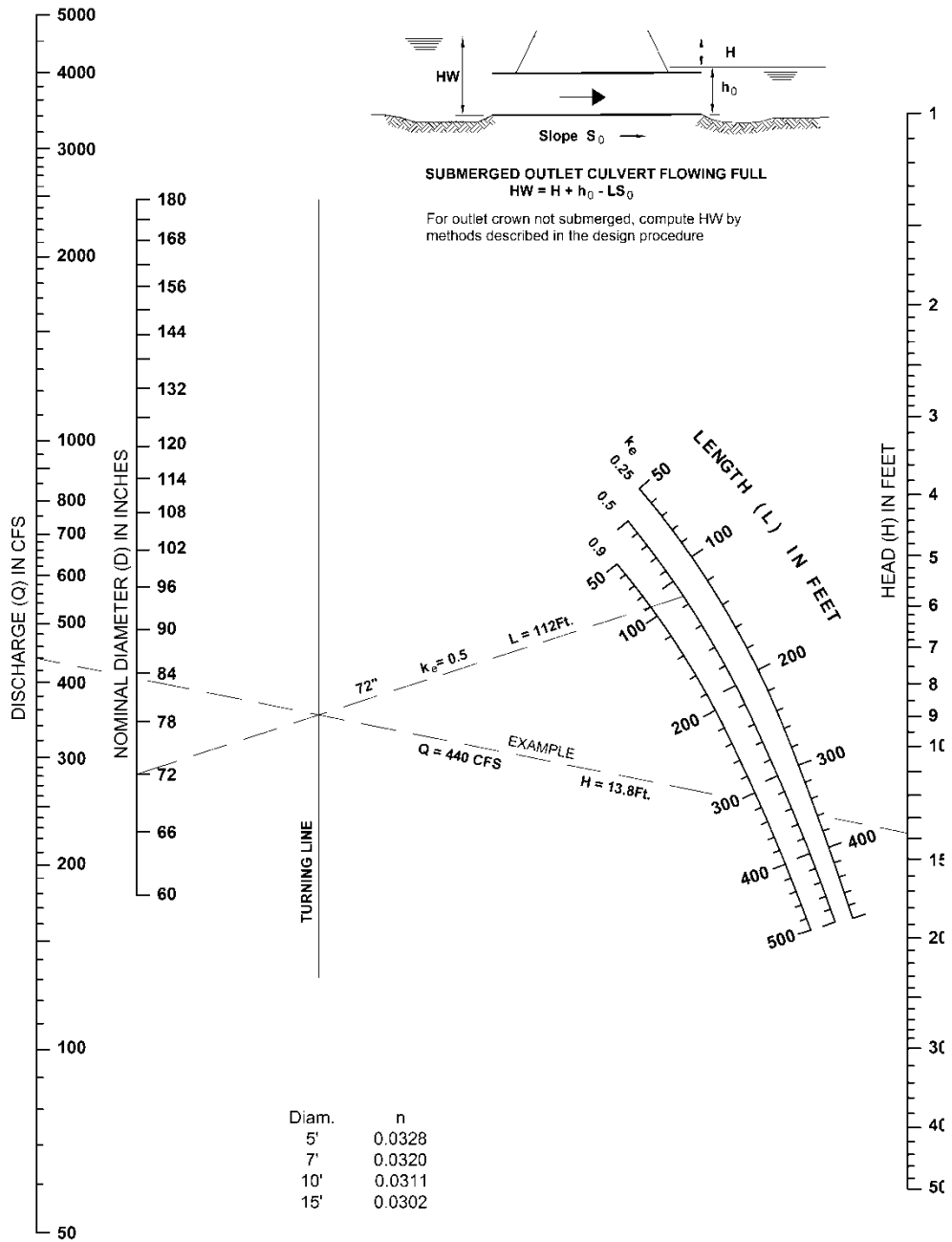

BUREAU OF PUBLIC ROADS, JAN. 1963

Figure 5603-13: Head for Structural Plate Corrugated Metal Pipe Culverts Flowing Full (n=0.0328 to 0.0302)

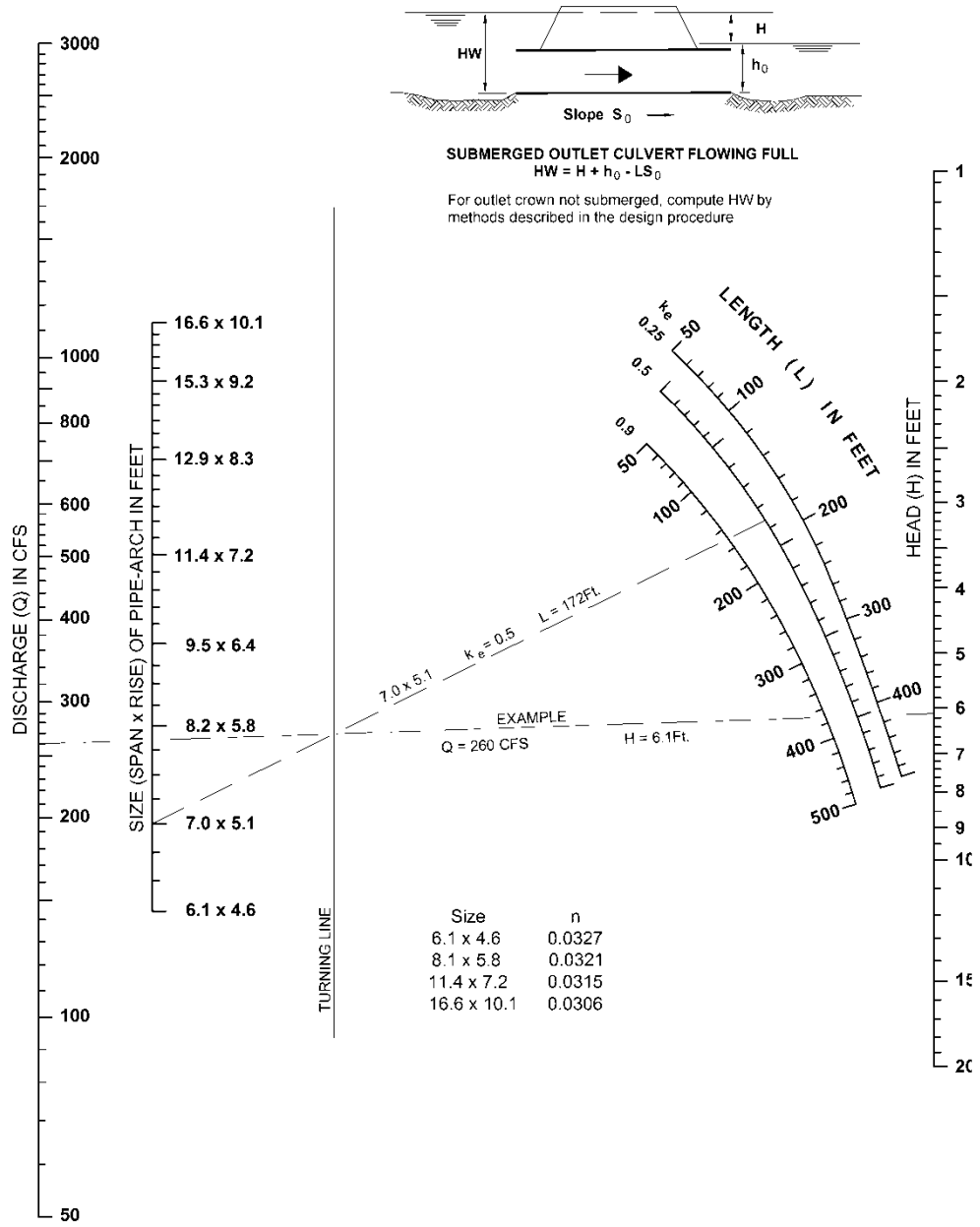

BUREAU OF PUBLIC ROADS, JAN. 1963

Figure 5603-14: Head for Structural Plate Corrugated Metal Pipe Arch Culverts, 18 inch Corner Radius, Flowing Full (n=0.0328 to 0.0302)

SECTION 5604 INLETS, MANHOLES AND JUNCTION BOXES

5604.1 Inlet Design

- A. Type:** Only curb opening inlets shall be used on public streets, except as approved by the City/County Engineer.
- B. Configuration:** These minimum dimensions (shown in Table 5604-1 and illustrated by Figure 5604-1) apply to either the lazy-back or steep-face type curbs:

Table 5604-1: Inlet Configuration Dimensions

Description	Dimension
Opening length, inside	4.0 ft (min)
Width, perpendicular to curb line, inside	3.0 ft (min)
Setback curb line to face	1.0 ft (min)
Opening, clear height	6.0 in. (min)
Gutter depression at inlet	6 ¼ in. (min)
Gutter transition length	
(a) Both sides in sump and upstream side on slopes	5.0 ft (min)
(b) Downstream on slopes	3.0 ft (min)

- C. Design Method:** Inlets should be designed using the methods prescribed in Section 5604.8 and/or Figures 5604-2 through 5604-19. Note that the Theoretical Captured Discharge (right side of chart) is the design capacity, 80 percent clogging factor should not be used for inlets on grade, unless deemed necessary by the engineer. Figures 5604-2 through 5604-19 describe inlet efficiency as a function of street slope (See Figure 5604-3 for design example) and in most cases will require the designer to add bypassed flow to the next downstream inlet. Figure 5604-21 describes inlet capacity for sump regions using HEC-22 equation 4-31a. Inlet capacity for sump regions shall be rated at 80 percent of the theoretical capacity to allow for partial obstruction and clogging. "Type CG-2 Curb" and "Type CG-1 Curb", as indicated on these figures, refers to the lazy-back and steep-face style curbs, respectively.

5604.2 Gutter Flow

Inlets shall be located to limit the width of flow in street gutters at the time of peak discharge for the design storm specified in 5601.8 B to the limits indicated in Table 5604-2.

Table 5604-2: Gutter Spread Criteria

Back to Back of Curb Street Width (feet)	Maximum Allowable Spread in Each Outside Curb Lane from Back of Curb* (feet)
28 or Less	12.0
Over 28 to 36	12.0
Over 36	12.0
Divided Roadways	As above for each direction roadway

* spread may exceed these limits within 50 feet of a sump inlet.

In addition to the inlet spacing requirements for limiting width of flow, inlets shall be locate to limit gutter flow from crossing the street centerline at the time of peak discharge for the design storm to the limits shown in Table 5604-3.

Table 5604-3: Inlet Bypass Spread Criteria

<u>Condition Causing Flow Crossing Street Centerline</u>	<u>Maximum Discharge (cfs)</u>
Sump at intersection return*	1.0
Transitions to superelevation	1.0
Sump at midblock	Not Allowed
Overflow of non-gutter flow	Per 5601.8.B

* For new development, inlets at intersections shall be positioned outside the curb return.

5604.3 Gutter Capacity

Izzard's Formula shall be used to determine gutter capacity (see Figure 5604-20 for graphical solution):

$$Q = \frac{0.56z \cdot S^{1/2} \cdot D^{8/3}}{n}$$

Where:

- Q = The gutter capacity in cubic feet per second
- z = The reciprocal of the average cross-slope, including gutter section, in feet per foot
- S = The longitudinal street grade in feet per foot
- D = The depth of flow at curb face in feet
- n = Manning's "n" (see Table 5603-1)

5604.4 Freeboard Requirements

Any opening which surface water is intended to enter (or may backflow from) the system shall be 0.5 feet or more above the hydraulic grade line in the inlet during the design storm, specified in Section 5601.8, where such calculation must include minor losses.

5604.5 Inverts and Pipes

The crown(s) of pipe(s) entering a drainage structure shall be at or above the crown of the pipe exiting from the structure and provide a minimum fall of the invert in the structure of 0.2 feet for straight flow through the structure or 0.5 feet fall for all other types of flow (bends more than 22.5 deflection angle, multiple lines entering, enlargement transition, etc.) through the structure. The desirable minimum fall across the invert is 0.5 feet. Alternatively, the crowns of the pipes may be at or above the EGL of normal flow at design frequency.

The maximum spacing between manholes shall be 500 feet.

5604.6 Loading Conditions for Structures

Loading shall be in accordance with Section 5710.3.

5604.7 Street Grade on Vertical Curves

The following formula shall be used to determine the street grade (S_x) at any point on a vertical curve using plus for grades ascending forward and minus for grades descending forward, in feet per foot.

$$S_x = S_1 + \frac{x \cdot (S_2 - S_1)}{L}$$

Where:

S_x = the street grade on a vertical curve at point x, in feet per foot

S_1 = the street grade at the PC of a vertical curve, in feet per foot

S_2 = the street grade at the PT of a vertical curve, in feet per foot

x = the distance measured from the PC to point x on a vertical curve, in feet

L = the total length of a vertical curve, in feet

5604.8 Curb Inlet Intercept Equations¹

- A. For any given set of conditions (curb type, inlet length, street grade and cross-slope), the relationship between the captured discharge and the total discharge can be approximated satisfactorily by an equation

$$Q_c = \left\{ \begin{array}{l} Q_t \text{ for } Q_t \leq Q_o \\ Q_o + (Q_a - Q_o) \left\{ 1 - \exp \left[- \left(\frac{Q_t - Q_o}{Q_a - Q_o} \right) \right] \right\} \text{ for } Q_t > Q_o \end{array} \right\}$$

of the form:

Q_o and Q_a are constants. The constant Q_o represents the largest discharge that is captured completely, and the constant Q_a represents the upper limit on the captured discharge, which is approached asymptotically with increasing total discharge. For a particular curb type and street cross-slope, Q_o and Q_a vary with inlet length (L_o) and street grade (S_o) according to the formulas

$$Q_o = (a + b \cdot L_o)(S_o)^x$$

$$Q_a = (c + d \cdot L_o)(S_o)^x$$

Where a, b, c, d and x are constants. Table 5604-4 shows these constants in U.S. customary units.

Table 5604-4: Values of Coefficients and Exponent

Curb Type	Sx, %	a	b	c	d	x
CG-1 (B)	2	1.0	0	3.2	1.7	-0.5
CG-1 (B)	4	1.5	0.5	2.6	1.9	-0.5
CG-2 (A)	2	-0.4	0.1	3.5	0.8	-0.7
CG-2 (A)	4	-0.3	0.3	4.3	2.5	-0.8

- B. Appendix A provides a Microsoft Visual Basic function that can be added to a Microsoft Excel (97 or later) worksheet or template for inlet intercept calculations.

¹ "Hydraulic Performance of Set-Back Curb Inlets", McEnroe et al., University of Kansas, 1998.

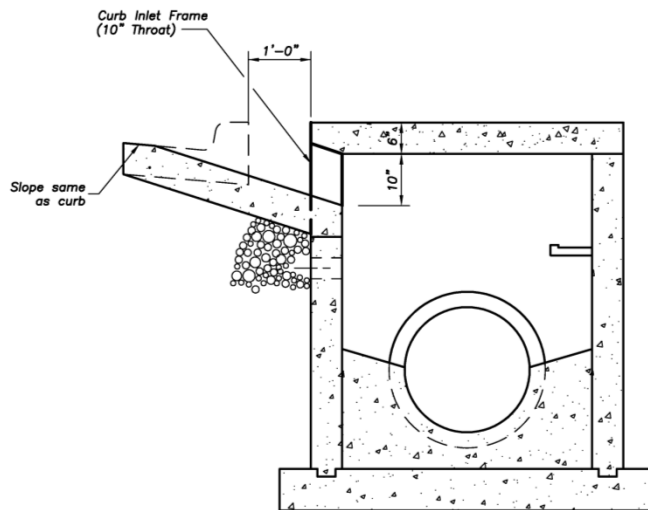
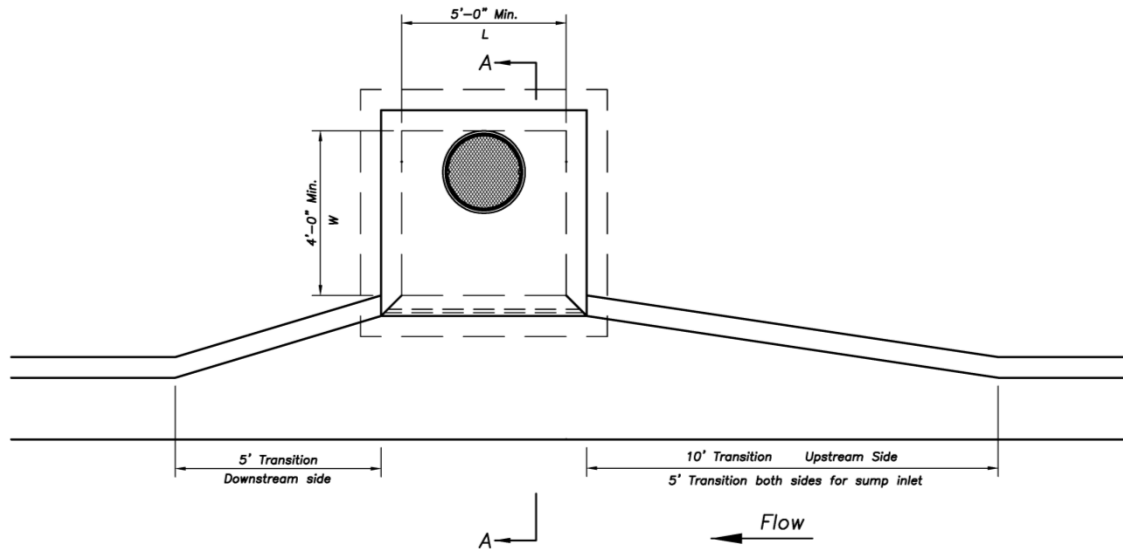

SECTION A-A
Not to Scale

Figure 5604-1: Curb Inlet (10' Throat) Minimum Hydraulic Dimensions

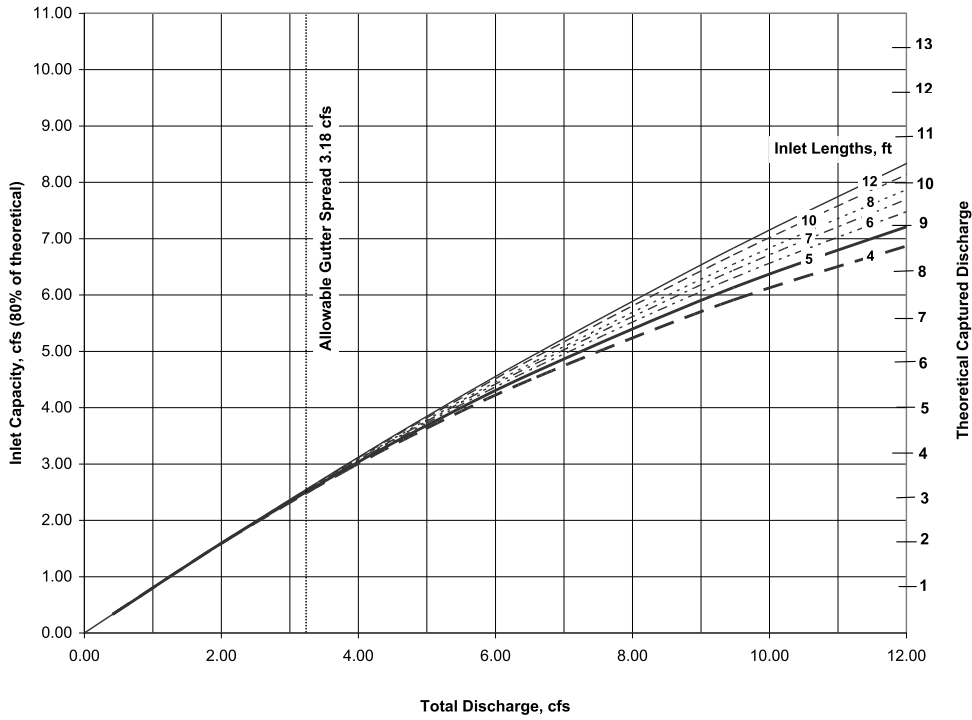

Figure 5604-2: Type CG-1 Curb, $S_x=2\%$, $S_o=0.5\%$

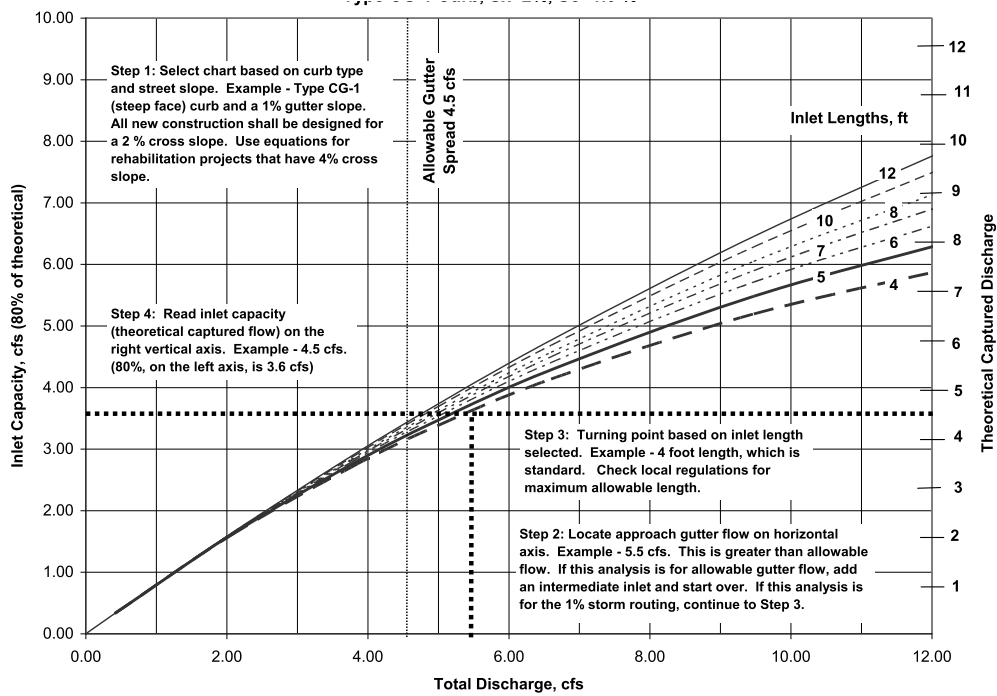

Figure 5604-3: Type CG-1 Curb, $S_x=2\%$, $S_o=1.0\%$

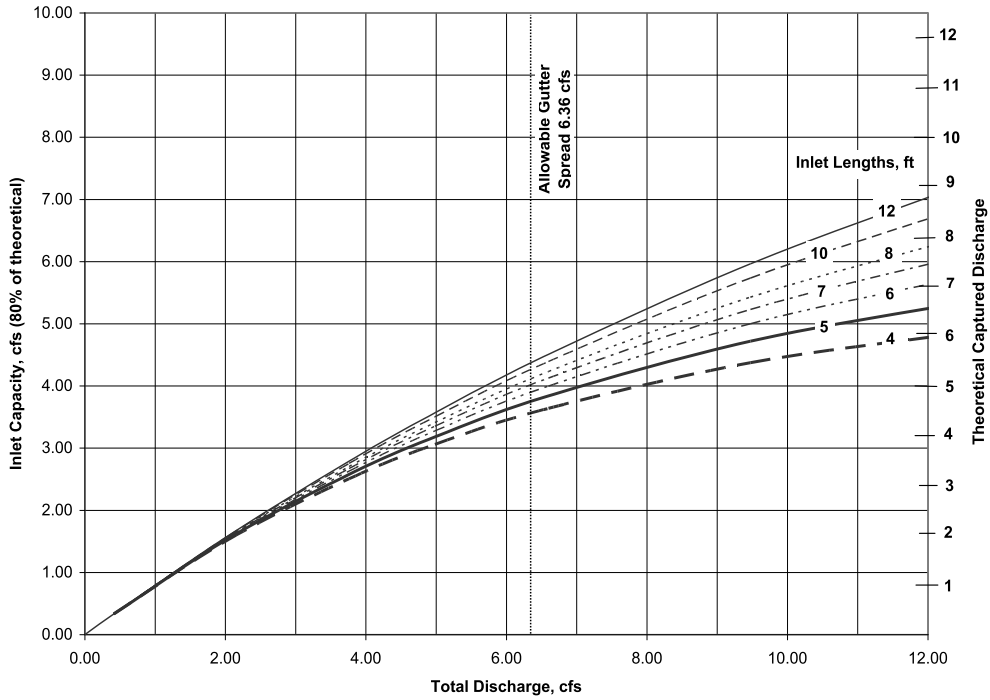

Figure 5604-4: Type CG-1 Curb, $S_x=2\%$, $S_o=2.0\%$

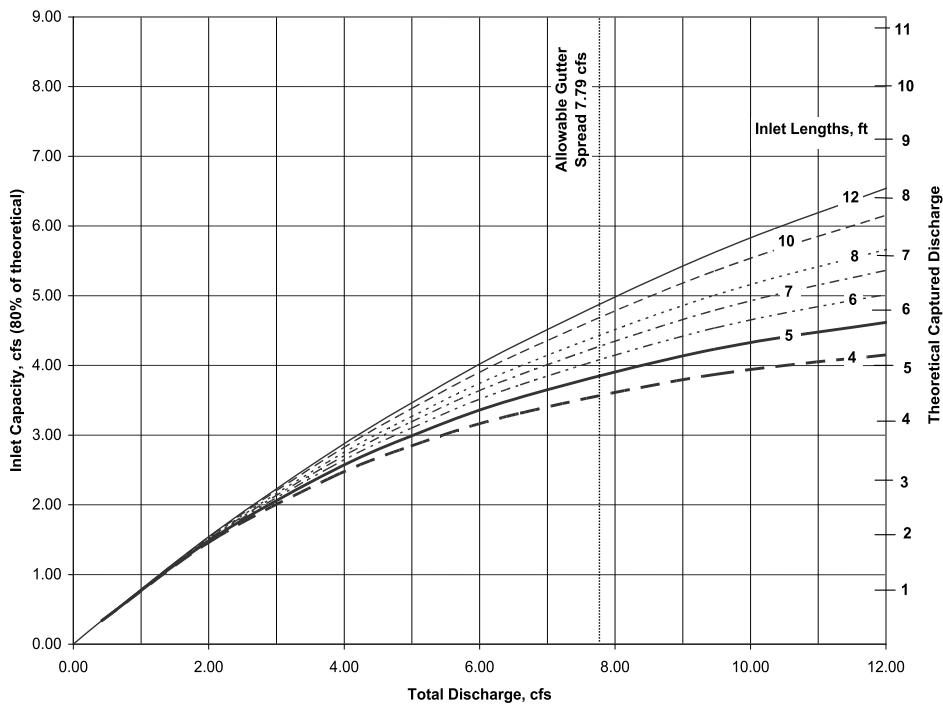

Figure 5604-5: Type CG-1 Curb, $S_x=2\%$, $S_o=3.0\%$

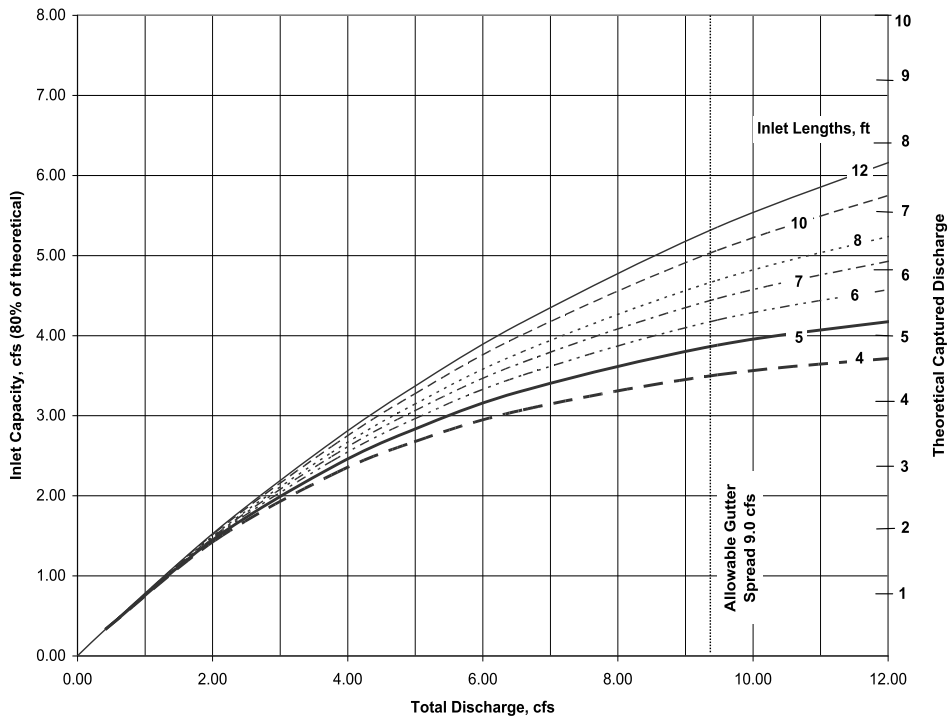

Figure 5604-6: Type CG-1 Curb, $S_x=2\%$, $S_o=4.0\%$

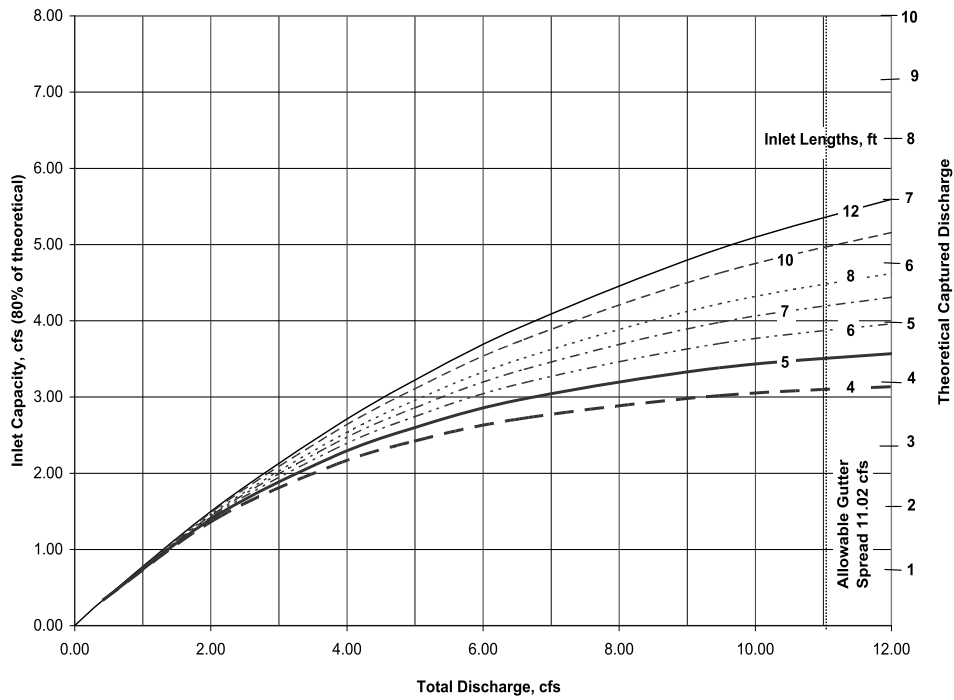

Figure 5604-7: Type CG-1 Curb, $S_x=2\%$, $S_o=6.0\%$

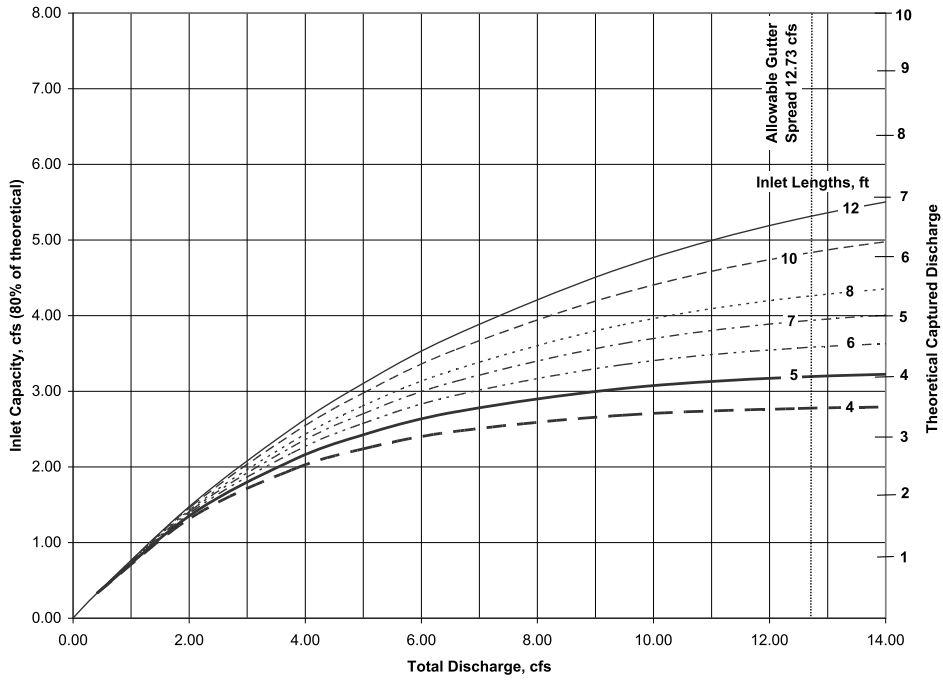

Figure 5604-9: Type CG-1 Curb, $S_x=2\%$, $S_o=8.0\%$

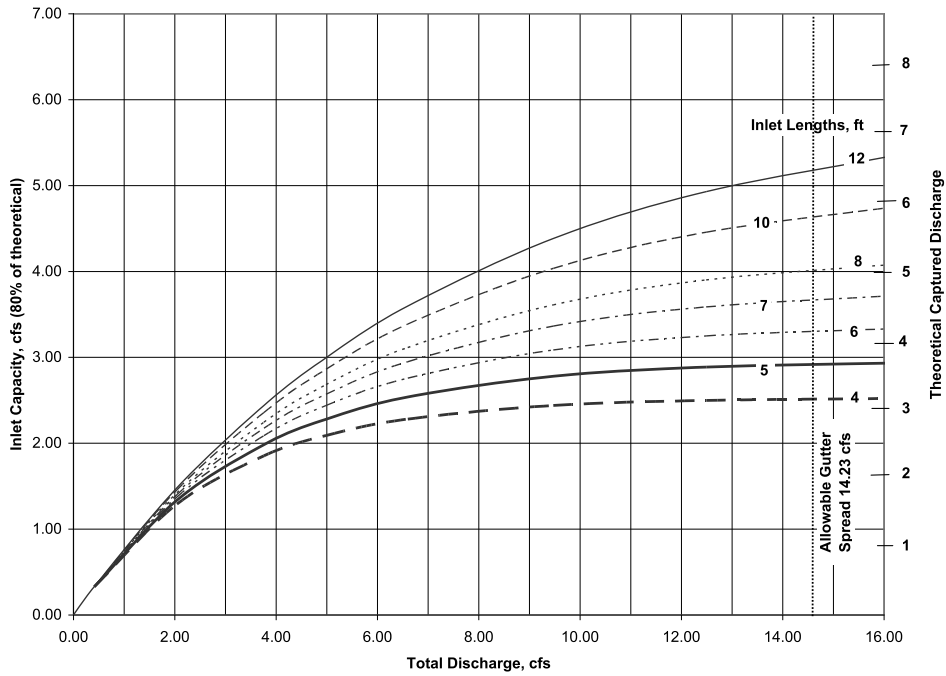

Figure 5604-8: Type CG-1 Curb, $S_x=2\%$, $S_o=10.0\%$

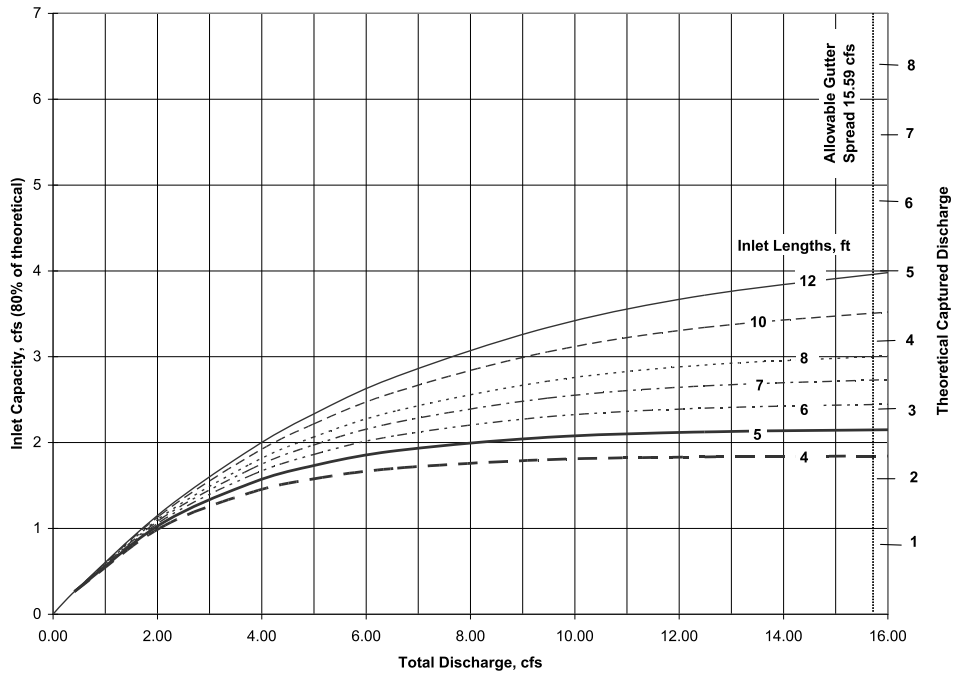

Figure 5604-10: Type CG-1 Curb, $S_x=2\%$, $S_o=12.0\%$

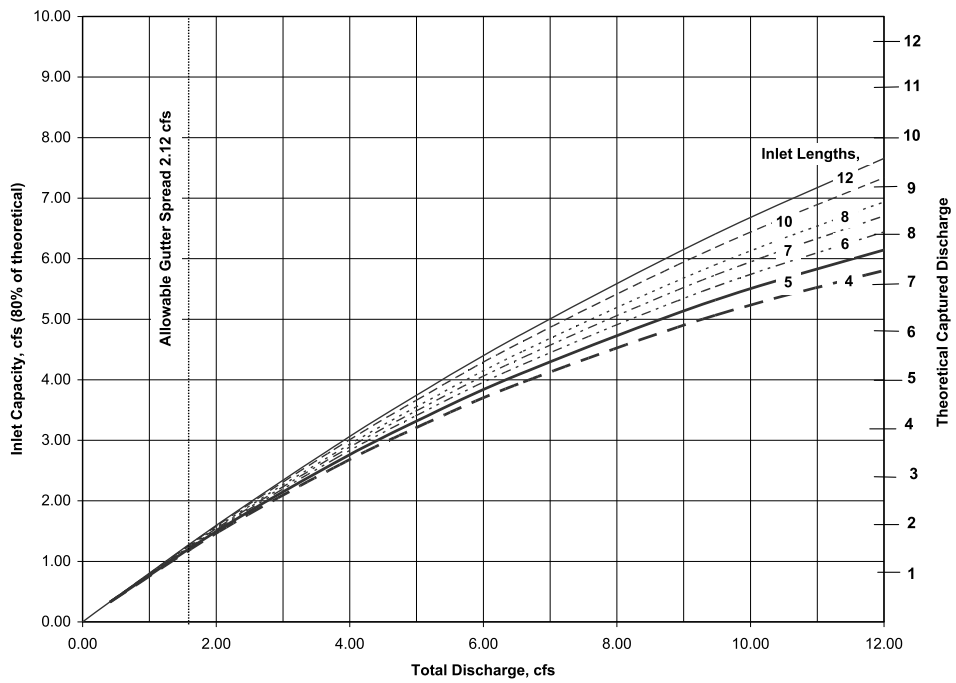

Figure 5604-11: Type CG-2 Curb, $S_x=2\%$, $S_o=0.5\%$

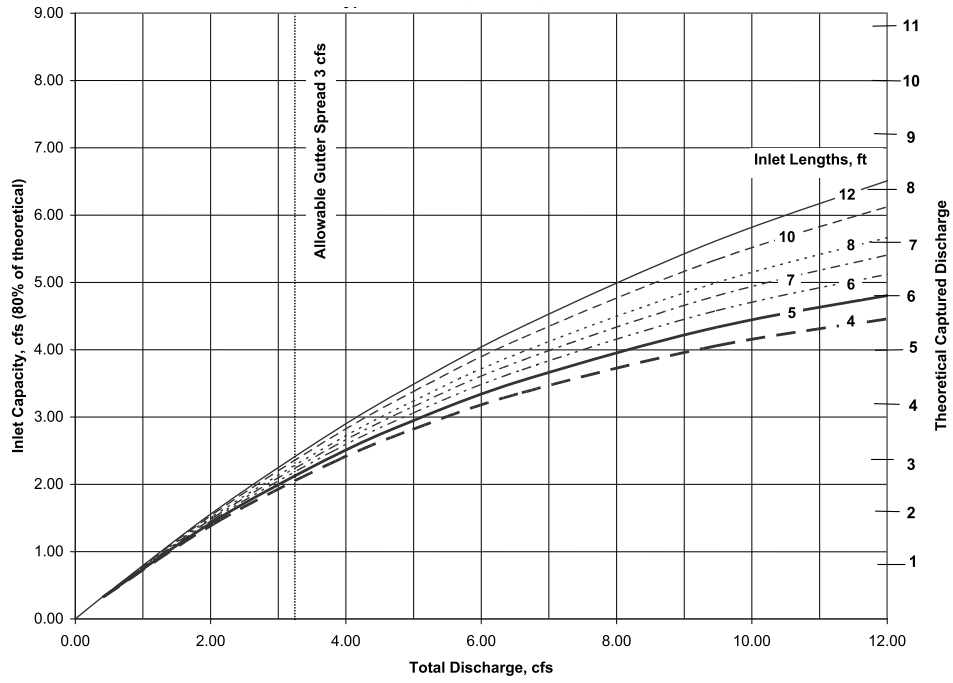

Figure 5604-12: Type CG-2 Curb, $S_x=2\%$, $S_o=1.0\%$

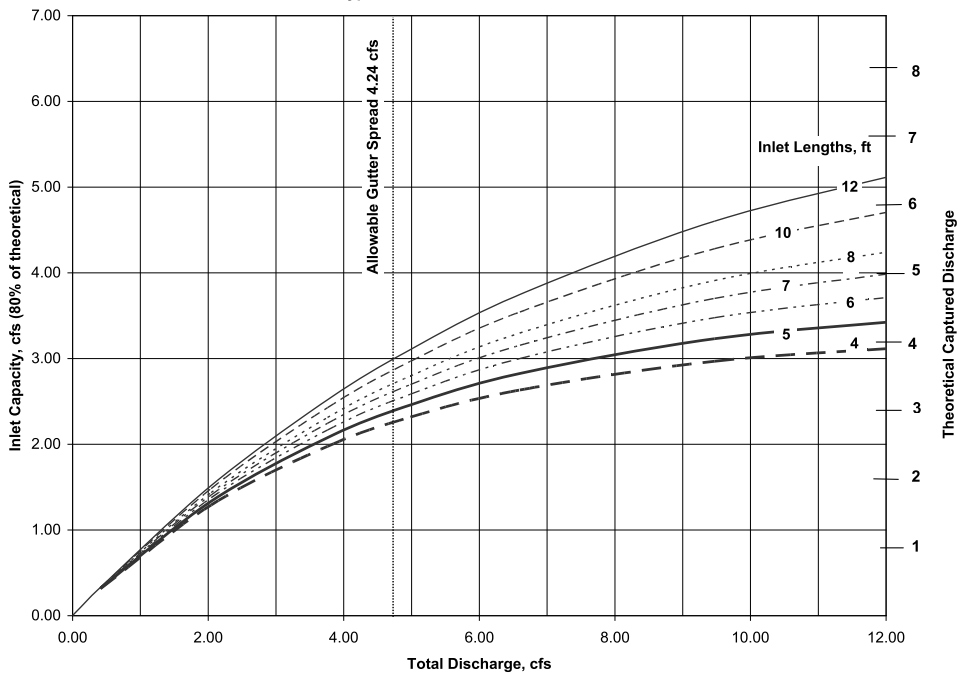

Figure 5604-13: Type CG-2 Curb, $S_x=2\%$, $S_o=2.0\%$

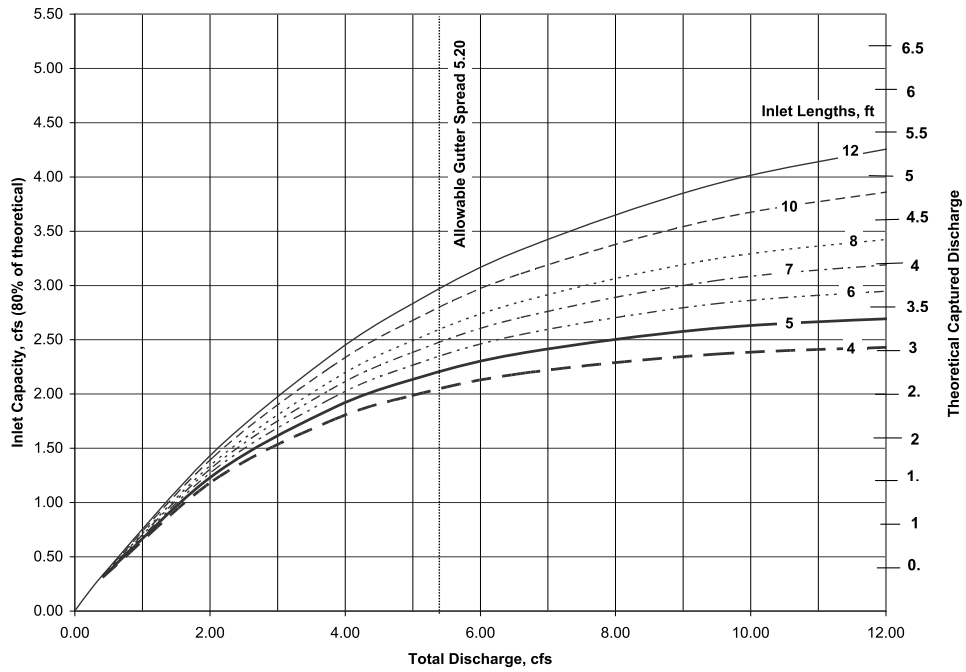

Figure 5604-14: Type CG-2 Curb, $S_x=2\%$, $S_o=3.0\%$

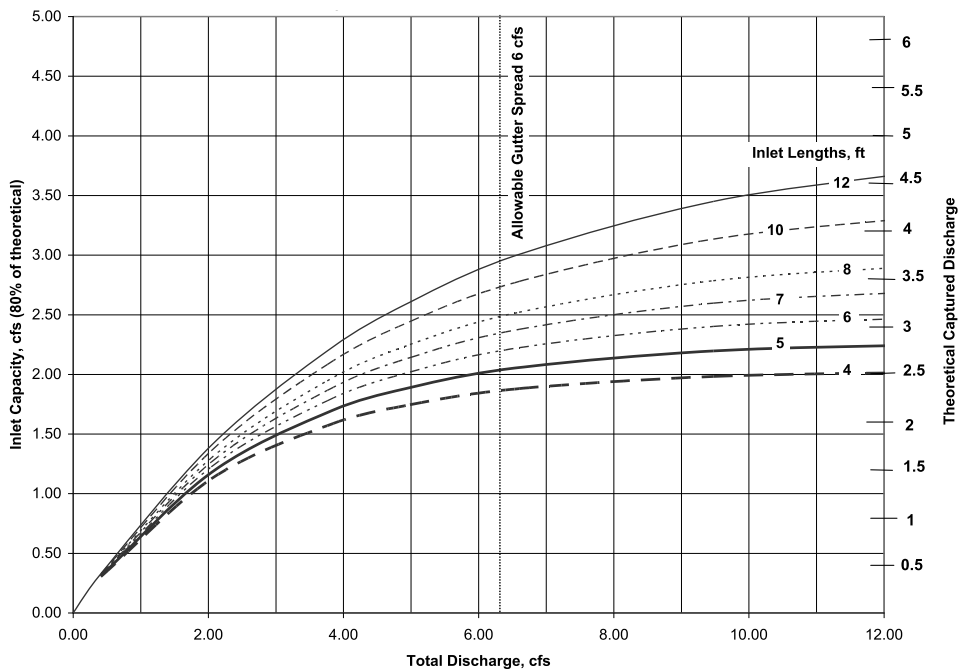

Figure 5604-15: Type CG-2 Curb, $S_x=2\%$, $S_o=4.0\%$

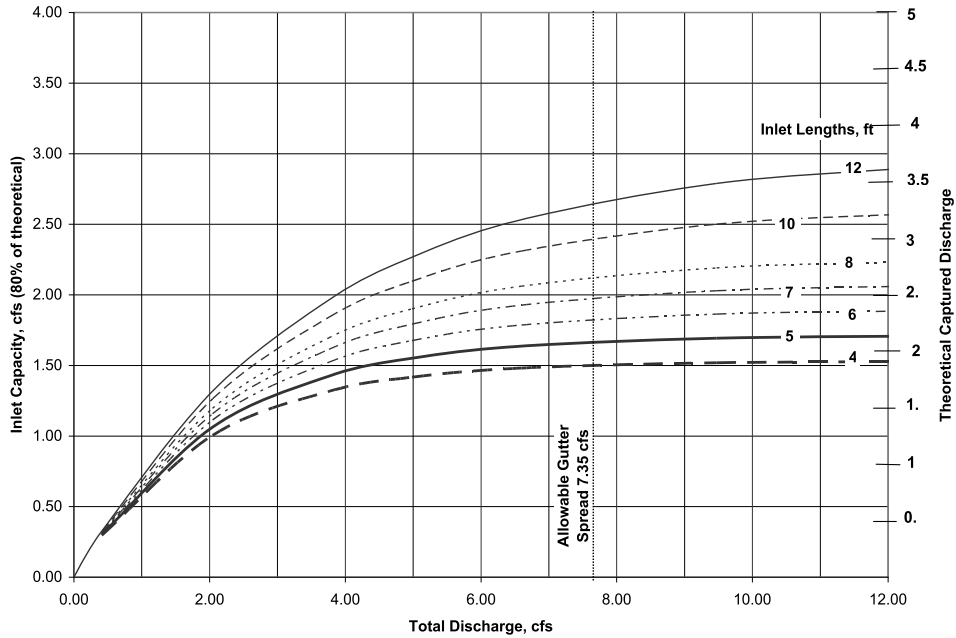

Figure 5604-16: Type CG-2 Curb, $S_x=2\%$, $S_o=6.0\%$

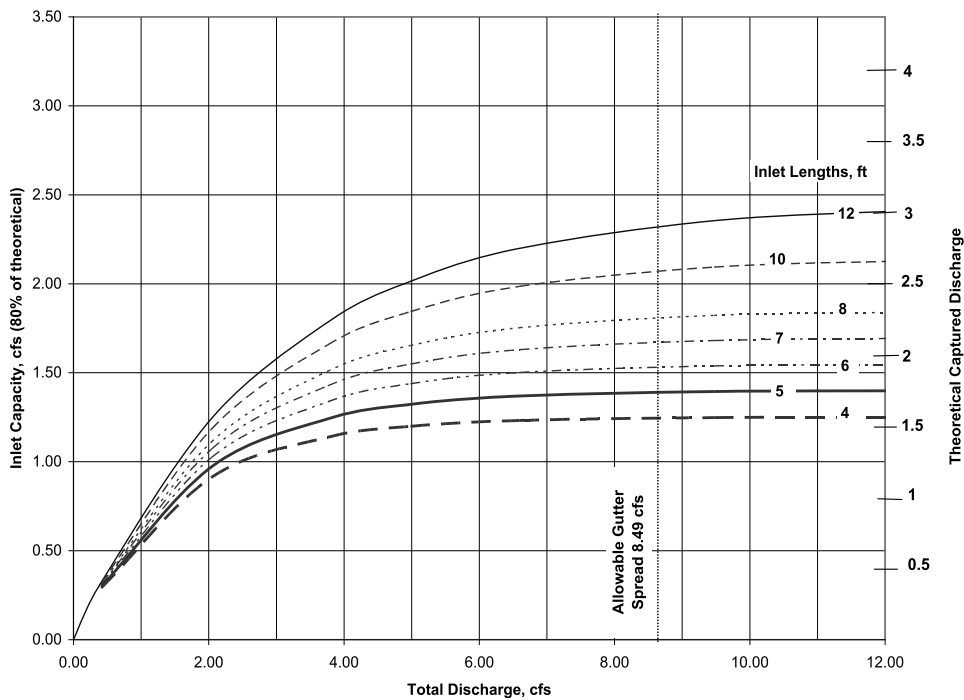

Figure 5604-17: Type CG-2 Curb, $S_x=2\%$, $S_o=8.0\%$

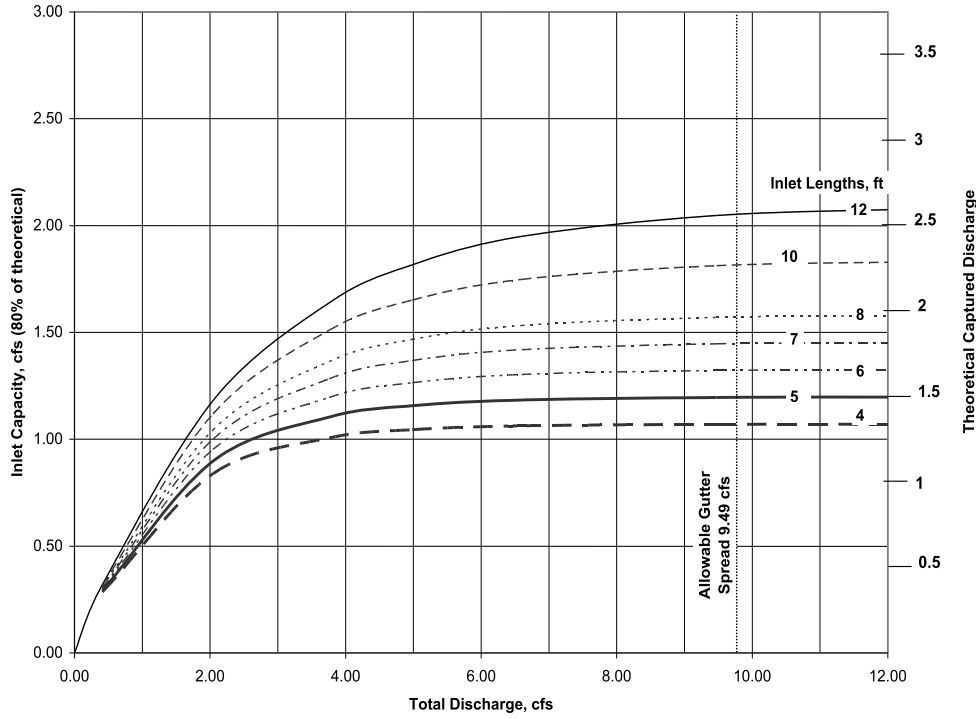

Figure 5604-19: Type CG-2 Curb, $S_x=2\%$, $S_o=10.0\%$

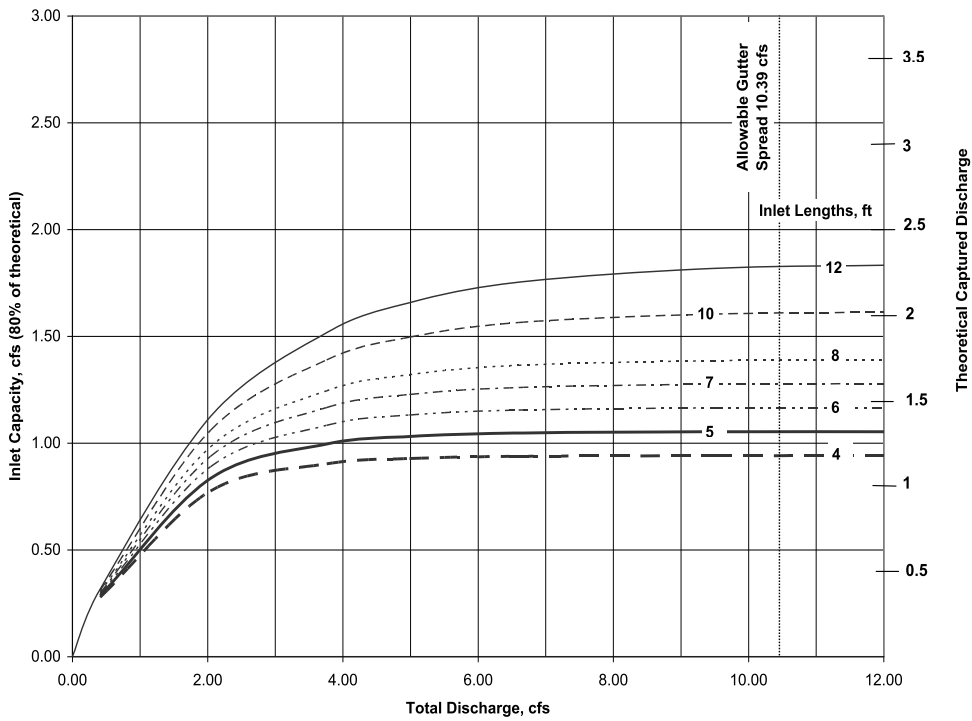

Figure 5604-18: Type CG-2 Curb, $S_x=2\%$, $S_o=12.0\%$

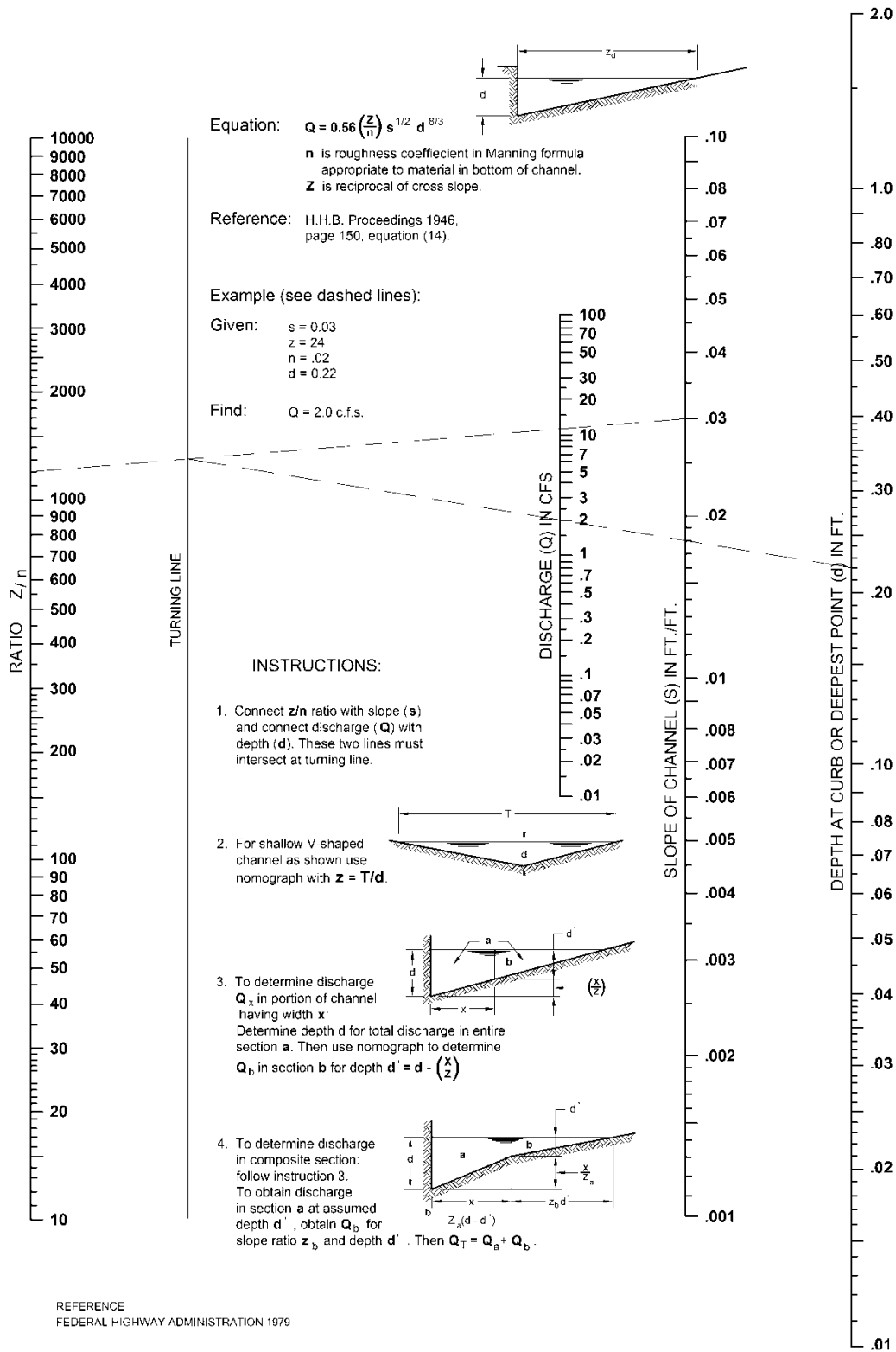
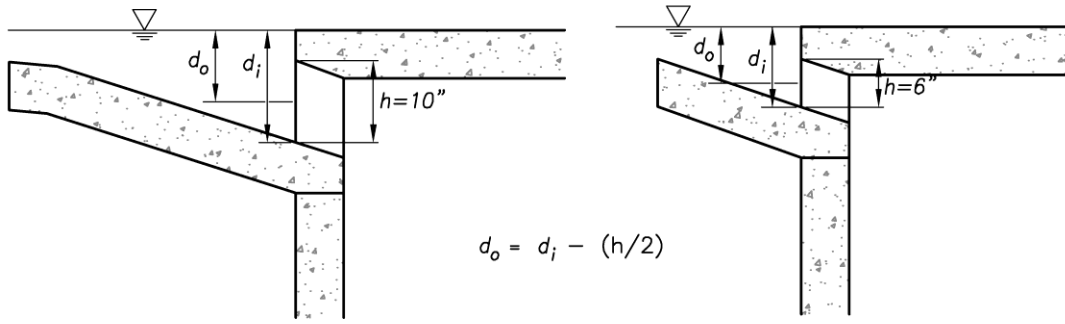

Figure 5604-20: Nomograph for Flow in Triangular Channels



TYPE 1 CURB INLET

TYPE 2 CURB INLET

Type	h	di	do	Qi	80% Qi
1	10"	14"	9"	3.9L	3.1L
2	6"	10"	7"	2.1L	1.7L

$$Q_i = C_o h L (2 g d_o)^{0.5}$$

- C_o = orifice coefficient (0.67)
- d_o = effective head on the center of the orifice throat, ft
- L = length of orifice opening, ft
- d_i = depth at lip of curb opening, ft
- h = height of curb opening orifice, ft
- g = gravitational constant, 32.2 ft/sec²
- Q_i = theoretical inlet capacity (cfs)

Figure 5604-21: Capacity of Curb Opening Inlet at Sump

SECTION 5605 NATURAL STREAMS

5605.1 Scope

This section sets forth requirements for the protection of natural streams as a conveyance for stormwater. Unless otherwise provided for by City, State, or Federal ordinance, regulation, or standards, existing natural streams shall be preserved and protected in accordance with this section. Where natural streams are not preserved, the drainage will be handled through systems designed in accordance with Sections 5606 and 5607.

5605.2 Natural Stream Benefits and Characteristics:

Natural streams provide numerous water quality, ecological, and quality of life benefits. Protection and preservation of natural streams is a national environmental objective, as set forth in the Clean Water Act. Streams and their associated wetlands provide critical habitat for plants and wildlife, water quality treatment, and improved infiltration of rainfall which lessens flood impacts, recharges groundwater, and preserves base flow. Streams provide recreational and open space in communities, improve aesthetics, provide natural landscapes, and enhance adjacent property values.

Stable streams in nature maintain a shape in plan, profile, and section that most efficiently transports the water and sediment supplied to them. The geometry and processes of natural streams involve unique terminology and concepts not common to engineered channels or pipe systems. Common features of stream geometry and characteristics are presented in Figures 5605-1 through 5606-3. Certain definitions are contained in Section 5601. More complete information regarding the character and function of natural streams is given in Interagency (2001).

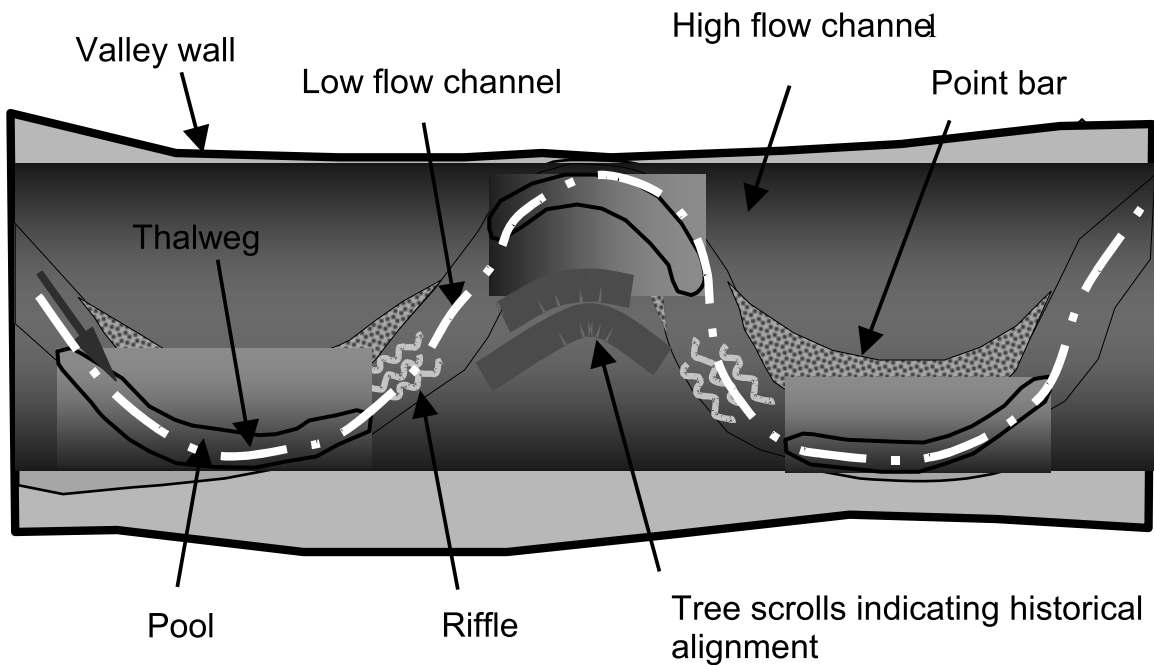

Figure 5605-1: Typical Stream Characteristics (1 of 3)

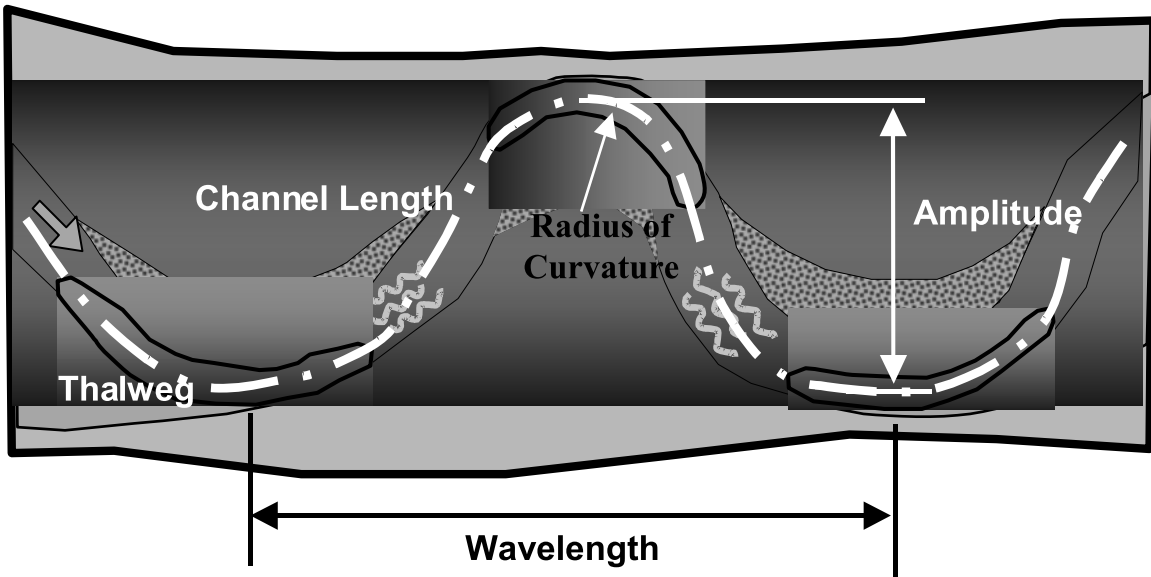

Figure 5605-2: Typical Stream Characteristics (2 of 3)

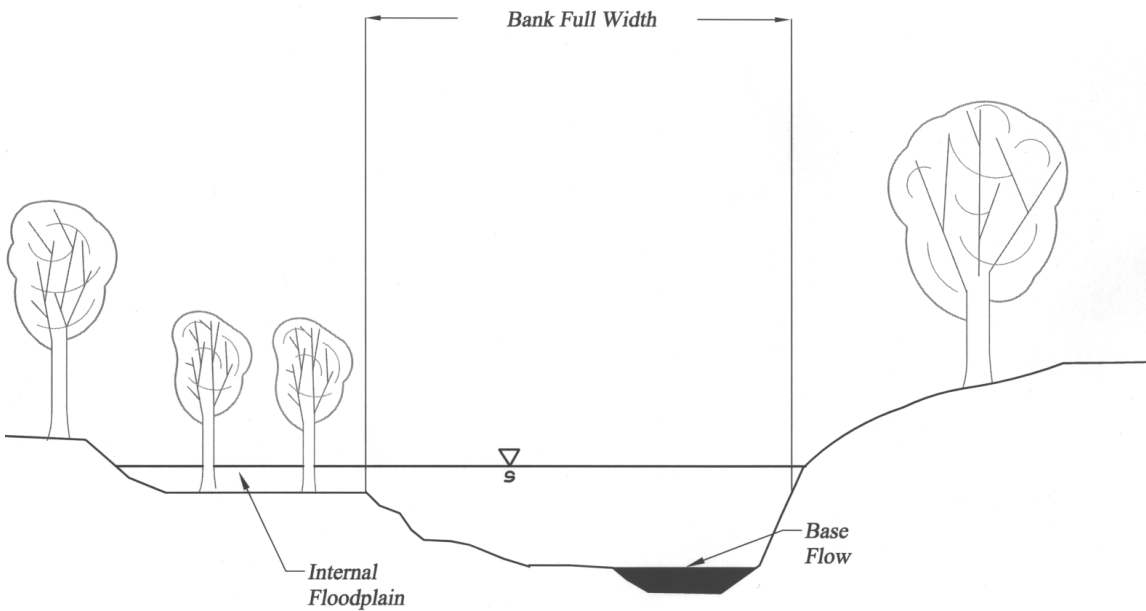

Figure 5605-3: Typical Stream Characteristics (3 of 3)

5605.3 Stream Preservation and Buffers Zones

- A. Recommended Approach:** It is recommended that Cities adopt comprehensive stream preservation and buffer zone requirements as part of their master plan and enforce those policies during the planning phase of land development. Requirements may be selected to protect environmental and quality of life benefits and be tailored to local geography and natural resources. The size of buffers may be adjusted to reflect local experience with stream migration and stability, protection of adjacent wetlands or critical habitat, or water quality treatment.

Guidance on stream protection is given in Wegner (1999), National Academy of Sciences (1999), and Heraty (1995). Natural streams should be preserved as systems and not segmented on a project-by-project basis, as the frequent intermixing of natural and man-made systems tends to degrade the function of both.

- B. Default Approach:** Where such comprehensive strategies have not been adopted, the following requirements shall be satisfied for all development/redevelopment proposed adjacent to or ultimately discharging to an existing natural channel:
 1. Streams having a tributary area in excess of 40 acres shall be preserved. Preservation of smaller streams is encouraged. Preservation may be waived by the City/County Engineer where it is impractical, provided that the project has also received appropriate state and federal permits.
 2. Buffer zones shall be established around all preserved streams. The limit of buffer zones shall be formally designated on a plat, deed, easement, or restrictive covenant, as directed by the City. Buffer widths as measured from the ordinary high water mark (OHM) outward in each direction shall exceed the dimensions shown in Table 5605-1.

Table 5605-1: Stream Buffer Widths

Contributing Drainage Basin Size (acres)	Buffer Width*
Less than 40 acres	40 feet
40 acres to 160 acres	60 feet
160 acres to 5000 acres	100 feet
Greater than 5000 acres	120 feet

*Measured from OHM outwards, measured separately in each direction

3. The City/County Engineer may require wider buffers for less stable stream or special conditions to address water quality and ecological needs. These widths provide only moderate allowance for widening or migration in local streams of average stability. Geotechnical studies may be required if there is a risk of slope failure due to underlying soil or rock materials, and the buffer width shall be expanded to contain the zone of failure. Smaller buffers in isolated locations may be allowed where provision of the full width is impractical and bank stability concerns have been addressed.
4. No construction or disturbance of any type, including clearing, grubbing, stripping, fill, excavation, linear grading, paving, or building is allowed in the buffer zone except by permission of the City/County Engineer. Dense stands of native vegetation shall be maintained, particularly in the 25 feet closest to the top of bank.
5. Unless otherwise accepted by the City/County, any maintenance of riparian buffers shall be the responsibility of the property owner.

6. For work on existing facilities already located closer to the stream than allowed above, the new construction shall not encroach closer to the stream. Bank stability concerns shall be addressed. Formal designation of a buffer zone is not required.

5605.4 In Stream Construction - General Requirements

Construction in streams or their buffer zones shall conform to the general requirements of this subsection and to the appropriate specific requirements of the subsections following:

- A. **Stream Assessment:** A stream assessment shall be conducted in accordance with Section 5605.5 for all construction within the buffer zone except for discharge outfalls, unless otherwise directed by the City/County Engineer.
- B. **Energy Management:** The pre-project and post-project hydraulic and energy grade lines for the 100%, 10%, and 1% storm flows shall be plotted. The region of a stream where in-stream construction causes a change in these grade lines is considered the zone of influence. The extent of the zone of influence downstream shall be generally limited by energy dissipation and grade control. The upstream limit of the zone may extend a distance beyond the construction as a drawdown or backwater curve. Within the zone of influence, the energy of the flow on the channel will be evaluated for the potential of excessive scour, deposition, initiation of head cuts, or other instability. Use of vegetation to increase bank resistance and minimize increases or abrupt changes in velocities is recommended. Bank or bed stabilization may be required in areas of unavoidable velocity or depth increase.
- C. **Sediment Transport Continuity:** The minimum post-project applied shear to the bed of the channel in the zone of influence at the 100%, 10%, and 4% ultimate conditions storm flow shall not be less than 90% of the minimum pre-project applied shear in the zone, so as to maintain the ability of the channel to transport sediment. If such shear stresses cannot be maintained, the engineer will evaluate the potential for future sediment removal or maintenance.
- D. **Transitions:** In-stream structures shall be designed to gradually blend into the natural channel and provide a smooth transition of both geometry and roughness.
- E. **Repair of Disturbed Banks:** The side slopes of banks where construction occurs shall be restored with vegetation in accordance with Section 5605-13 as quickly as possible.
- F. **Professional Judgment:** Natural streams are complex, variable, and strongly governed by local geology and climate. These standards are based on general guidelines of good practice on typical local streams and may not be optimal or sufficient in all cases. Specific requirements may be increased or waived by the City/County Engineer if conditions warrant and decisions should be guided by prudent engineering judgment.

5605.5 Stream Assessment

When conducted, a stream assessment will extend a minimum of one wavelength up and downstream of the area to be impacted by construction. It shall include the components listed below, except modified by the City/County Engineer to better fit project needs. An example submittal is shown in Figures 5605-4 and 5605-5.

- A. **Plan Form Analyses and Inventory:** The plan-view of the natural stream using aerial photographs or planning-level aerial survey shall be plotted to an appropriate scale. Field surveys of the entire reach study area are not required. The following items shall be shown:
 - Ordinary high water mark.
 - Top of bank.
 - Ground contours (if available).
 - "Bank-full" and floodplain for the 1% ultimate-conditions storm (see paragraph B).

- Thalweg, locations of riffles and pools, and spacing between riffles (see paragraph C).
- Exposed bedrock, areas of differing bed and bank soil or rock materials, and the D_{50} and shear stress ratio at each riffle (see paragraph D)
- Active scour and depositional areas, point bars, and islands.
- Vegetation within the buffer zone, called out as mowed grass, mowed with trees, unmowed grass and plants, wooded, and bare. Trees greater than 6" diameter within 25 feet of the top of bank shall be located individually or by group. The species of dominant trees should be noted.
- Meander length, wavelength, meander amplitude, bank-full width, and radius of curvature for each bend.
- Total meander and valley length and sinuosity for the reach.
- Photographs of main channel, streamside vegetation, and each riffle, appropriately referenced to plan-view location.

B. Bank-full Width, Depth and Discharge: If directed by the City/County Engineer, the geomorphic "bank-full" width, depth, and discharge shall be estimated using field indicators as detailed in Chapter 7 of USDA (1994). If field indicators are not used, "bank-full" flow shall be estimated as the rural-conditions 50% storm flow, and the bank-full width and depth estimated based on the dimensions of that flow through the existing channel. This assumption is intended to provide a rough upper estimate of the bank-full flow.

C. Longitudinal Profile and Sections: The elevations of the profile along the thalweg shall be field surveyed to the nearest 0.1 ft. and the following features noted: riffles, pools, exposed bed rock, and advancing head cuts (areas of bed elevation change that appear to be actively migrating upstream). The top of left and right bank and any field indicators of bank-full flow such as limits of woody vegetation or top of point bars shall be plotted at correct elevation along the profile. The bank-full flow and 1% ultimate storm flow profiles shall be plotted.

One field cross section shall be surveyed through each pool and riffle, and the depth and width of bank-full flow and floodplain for the 1% ultimate conditions storm shall be shown on each section.

D. Bed and Bank Materials Analyses: The type of rock exposed in the bed and banks shall be identified. Bank soils shall be reported by Uniform Soil Classification using the visual-manual procedures (ASTM D 2488-00). The median (D_{50}) particle size shall be determined using the Wolman Pebble Count Method (USDA, 1994, Chapter 11). A shear stress ratio shall be calculated for each riffle based on the applied shear at bank-full flow divided by the critical shear of the D_{50} particle in the riffle, using methods and tables described below.

E. Critical Shear Stress Analysis: The shear stress ratio must be less than one at the extreme downstream point of any development in accordance with the guidelines below:

1. The average applied shear stress (τ_0) may be calculated from the hydraulic data as follows:

$$\tau_0 = \gamma \cdot R \cdot S$$

Where:

γ = the specific weight of water (62.4 pounds per cubic foot)

R = hydraulic radius at bank-full flow (feet)

S = the water surface slope along the main channel bank full flow, averaged over several bends in the area of the intervention.

Effective flow may be calculated using methods described in detail in USACE 2001 or may be assumed to be equivalent to the 50% storm.

2. The critical shear stress (τ_c) is that at which particles in the bed or bank are entrained and scour ensues. Shield's method is used for calculating the calculating the critical shear stress of spherical, non-cohesive particles, as follows:

$$\tau_c = \theta(\gamma_s - \gamma)D_{50}$$

Where

γ_s = the specific weight of sediment

γ = specific weight of water (62.4 lb/ft³)

D_{50} = the median particle size in the surface layer of bed or banks

θ = the Shield's parameter (0.06 for gravel to cobble, 0.044 for sand)

There are limited methods for calculating τ_c for fine-grained material. Field or laboratory testing generally determines the critical shear stress for these materials. The most widely available source is Chow (1988). Table 7-3, p. 165 is particularly relevant. More recently, the USDA Agricultural Research Service National Sedimentation Laboratory has developed computer software for calculating toe scour (ARS Bank-Toe Erosion Model, Prototype, August 2001). As part of that software, there are look-up tables.

The combination of these two sources is presented in 5605-2 Critical shear stress may also be determined from Urban Water Resources Research Council (1992), Figure 9.6, p. 335.

In lieu of calculated values, the critical shear stress from Table 5605-2 may be used. Table 5605-2 presents critical shear for sediment-laden water and where noted, clear water. The user must exercise judgment as to future conditions. Clear water values may be used below a heavily piped area, concrete channels designed to contain the future flows or immediately below a managed detention pond.

3. The ratio of average boundary stress to critical stress is the shear stress ratio:

$$\text{shear stress ratio} = \frac{\tau_o}{\tau_c}$$

If bed and bank materials are distinct, then the shear stress ratio should be calculated for each. If the shear stress ratio of either stream bed or bank is greater than one, the channel is prone to near-term adjustment and any interventions should be designed to prevent accelerated erosion. If the bed consists of rock, then the shear stress ratio is not applicable, unless the rock is prone to fracturing, slaking, or break-up, in which case the median size of particle should be used for calculation of the ratio.

Table 5605-2: Critical Shear Stresses For Channel Materials

(Solely for use in stream assessments as described in Section 5605.5. Not to be used as allowable shear stresses for design)

Material	Shear Stress (psf)
Granular Material	
Boulders (100 cm)	20.295
Boulders (75 cm)	15.222
Boulders (50 cm)	10.148
Boulders (25.6 cm)	5.196

Table 5605-2: Critical Shear Stresses For Channel Materials

(Solely for use in stream assessments as described in Section 5605.5. Not to be used as allowable shear stresses for design)

Material	Shear Stress (psf)
Rip Rap	3.132
Cobbles (6.4 cm)	1.299
Cobbles and shingles	1.100
Cobbles and shingles, clear water	0.910
Coarse sand (1mm)	0.015
Coarse sand (1mm)	0.015
Coarse gravel, noncolloidal (GW), clear water	0.300
Coarse gravel, noncolloidal, (GW)	0.670
Gravel (2cm)	0.406
Fine gravel	0.320
Fine gravel, clear water	0.075
Fine sand (0.125 mm)	0.002
Fine sand (0.125 mm) (SP)	0.002
Fine sand (SW), (SP), colloidal	0.075
Fine sand, colloidal, (SW), (SP), clear water	0.027
Graded loam to cobbles, noncolloidal (GM)	0.660
Graded loam to cobbles, noncolloidal,(GM), clear water	0.380
Graded silts to cobbles, colloidal (GC)	0.800
Graded silts to cobbles, colloidal, (GC), clear water	0.430
Fine Grained	
Resistant cohesive (CL), (CH)	1.044
Stiff clay, very colloidal, (CL)	0.460
Stiff clay, very colloidal, (CL), clear water	0.260
Moderate cohesive (ML-CL)	0.104
Ordinary firm loam (CL-ML)	0.150
Ordinary firm loam, (CL-ML), clear water	0.075
Alluvial silts, colloidal (CL-ML)	0.460
Alluvial silts, colloidal,(CL-ML), clear water	0.260
Alluvial silts, noncolloidal (ML)	0.150
Alluvial silts, noncolloidal, (ML), clear water	0.048
Sandy loam, noncolloidal (ML)	0.075

Table 5605-2: Critical Shear Stresses For Channel Materials

(Solely for use in stream assessments as described in Section 5605.5. Not to be used as allowable shear stresses for design)

Material	Shear Stress (psf)
Sandy loam, noncolloidal, (ML), clear water	0.037
Silt loam, noncolloidal (ML)	0.110
Silt loam, noncolloidal, (ML), clear water	0.048
Shales and hardpans	0.67
Others	
Jute net	0.46
Plant cuttings	2.09
Well established dense vegetation to the normal low water	2.16
Geotextile (synthetic)	3.01
Large Woody Debris	3.13

Note: For non-cohesive soils, the table values are based on spherical particles and Shield equation, as follows: $\tau_c = \Theta(\gamma_s - \gamma) D$ where γ_s is the specific weight of sediment (165 pcf), γ is specific weight of water, D is the reference particle size, and Θ is the Shield's parameter (0.06 for gravel to cobble, 0.044 for sand). For cohesive soils the values are based on limited testing as reported in Chow (1988) and USDA (2001).

- F. Plan-Form Ratios:** The following ratios shall be calculated, and those that lie outside the typical range shall be noted. Streams are highly variable and ratios outside these ranges do not necessarily indicate problems.

Table 5605-3: Plan-Form Ratios

Ratio	Typical Range
Meander length / Wavelength (sinuosity)	1.1 to 1.5
Meander length / Bank-full width	10 to 14
Radius of curvature / Bank-full width	2 to 5
Riffle Spacing / Bank-full width	5 to 7

- G. Channel Condition Scoring Matrix:** Using information summarized above, the channel condition scoring matrix given in Table 5605-4 shall be completed. A rating of 12 indicates a stream of moderate stability that will likely require only standard levels of protection during construction. A rating between 12 and 18 indicates that special measures may be necessary address those issues rated as poor in the assessment. Streams with a rating greater than 18 may exhibit significant system-wide instability. These streams should be studied in more detail by experts in river engineering and fluvial geomorphology. (This scoring system is newly developed and its results shall be considered provisional.)

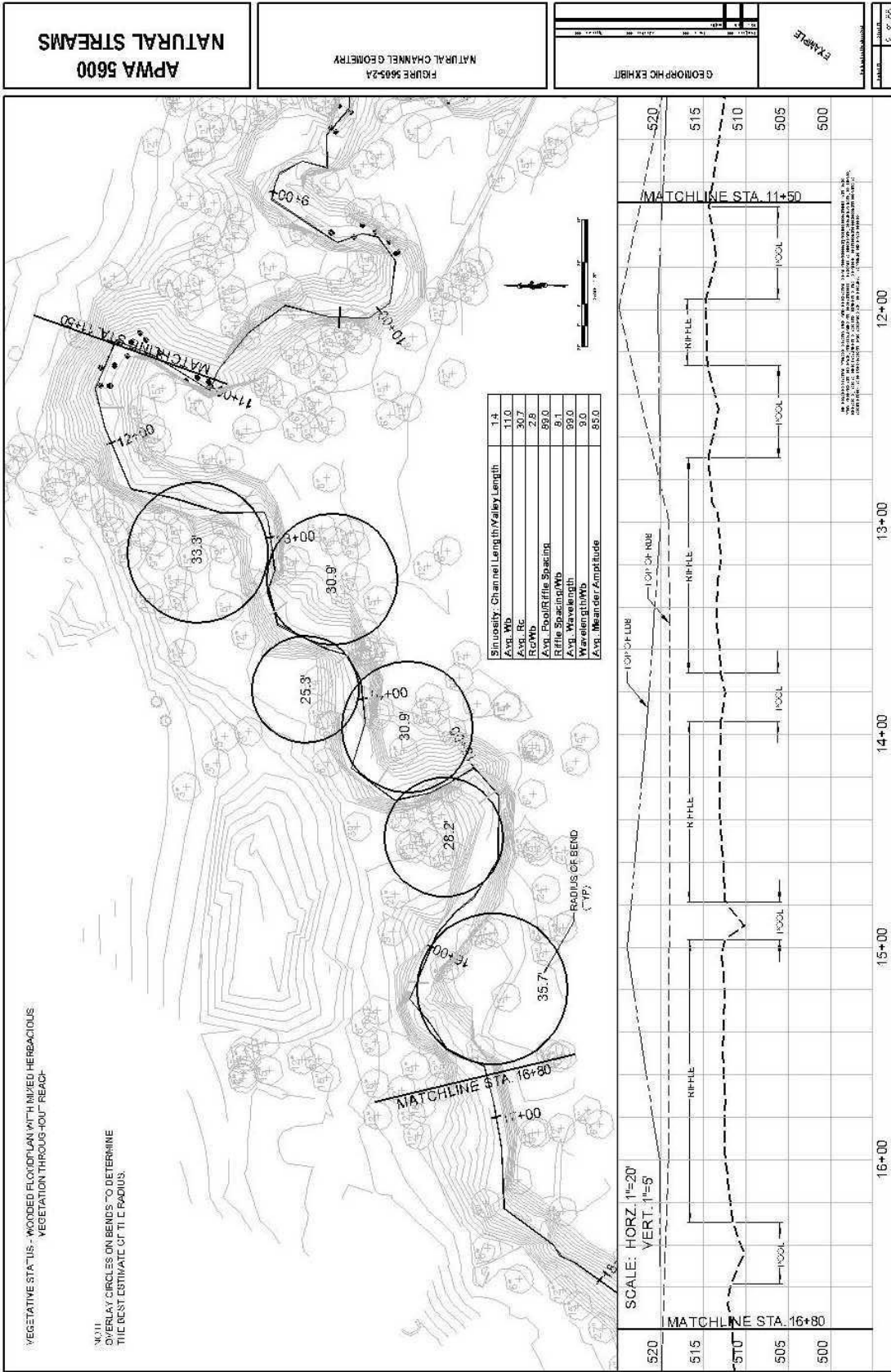

Figure 5605-4: Natural Channel Assessment

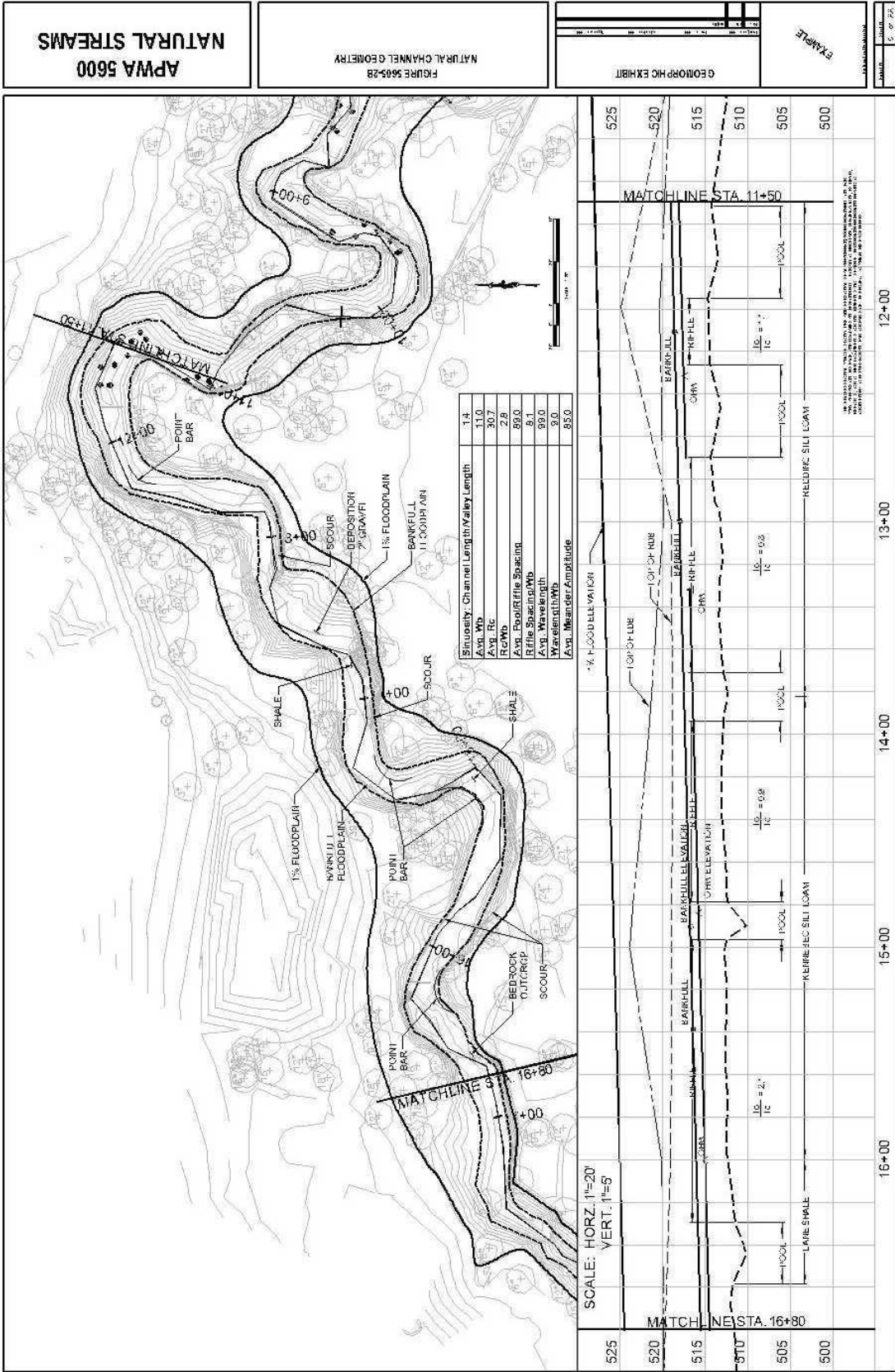

Figure 5605-5: Natural Channel

5605.6 Discharge Outfalls

Discharge points for inflows from enclosed systems or constructed channels shall be designed as one of the following. Energy management and sediment continuity checks are not required; however, energy dissipation shall be provided to reduce post development shear stress to pre-development shear stress at the outfall:

- A. Primary outfalls are those where the entire upstream channel is replaced by an enclosed system or constructed channel which discharges flow in line with the direction of the downstream segment. Energy dissipation should be provided at the outlet to reduce velocities per Section 5606.4. Grade control downstream of the outlet and energy dissipater should be provided to prevent undermining of the outfall by future head cuts per Section 5605.10. The alignment and location of the outfall and associated energy dissipater and grade control should make a smooth transition into the downstream channel. Primary outfalls shall be used whenever the contributing drainage area of the outfalls is greater than 80% of the downstream channel.
- B. Tributary outfalls are primary outfalls located on a tributary to a larger downstream segment. Energy dissipation and transition to natural stream flow should take place in the tributary at least one channel width upstream of the confluence per Section 5606.4. Grade control in the tributary upstream of the confluence shall be provided if the tributary flow line is higher than the adjoining channel or if future incision of the adjoining channel is anticipated. Tributary outfalls may be used in all situations of tributary flow.
- C. Lateral outfalls are small outfalls that discharge from the banks of a natural stream. Outfalls shall be located to enter on a riffle or from the outside of a bend, but should generally not enter from the inside of a bend. Outfall pipes shall be oriented perpendicular to the flow of the stream with the invert at or slightly below top of the next downstream riffle. Outfalls shall be flush with or setback from the bank. The bank shall be shaped to provide a smooth transition and protected with reinforced vegetation (preferred) or riprap. If the outfall is in a bend, it shall be set back from the existing bank a sufficient distance to account for future meander migration, and the transition shall be graded and reinforced with vegetation. Riprap or hard armor protection should not be used in a bend. Perpendicular outfalls may only be used when the contributing drainage area of the outfall is less than 40% of that in the downstream channel.
- D. Edge-of-buffer outfalls are discharge points in the outer half of the riparian buffer that return the discharge to diffused overland flow. Outfalls shall be designed to spread flow and allow overland flow and infiltration to occur. Overland flow shall be directed to run in the outer portion of the buffer parallel to the channel direction to increase length of flow and prevent short-circuiting directly into the stream. Low weirs and berms may be graded to direct flow and encourage short-term ponding. The buffer zone utilized for infiltration shall be maintained in dense, erosion-resistant grasses or grasses reinforced with turf-reinforcing mats designed to withstand the shear stresses of a 10% storm. Edge-of-buffer outfalls that are part of a system of upland drainage using multiple small, distributed overland swales and ditches instead of pipes may provide significant infiltration and water quality treatment. Edge-of-buffer outfalls shall only be used if each individual outfall can be designed to operate without scour or the formation of gullies.

5605.7 Culverts, Bridges, and Above Grade Crossings

- A. Crossings should generally be located on a riffle. If the width of the crossing is large relative to the length of the riffle, then grade control structures shall be provided at the riffles upstream and downstream to isolate the impact of the crossings. If a crossing cannot be made at a riffle, avoid armoring a pool and place at-grade grade control structures at the riffle immediately upstream and downstream of the crossing. Maintain sediment transport continuity and avoid altering the channel cross-section.
- B. Realignment of channels to accommodate crossings and their approach should be avoided and minimized as much as possible. Any areas relocated shall have the banks stabilized in accordance with 5605.13 and shall be included in the reach isolated by upstream and downstream grade control.
- C. For bridges the multi-stage channel shape should be maintained and additional area to convey the design flow shall be above the elevation of the bank-full discharge.

- D. For multi-cell pipe and culvert crossings that have a cumulative width larger than the bank-full width, those cells wider than the bank-full width shall have a flow line located at the lowest estimated bank-full depth, or a weir wall or other structure upstream of the culvert opening shall be installed with a height to prevent access to the cell during flows less than bank-full flow. The weir wall shall be designed so that the hydraulic efficiency at the 1% ultimate conditions storm is not reduced. Without these features, the culvert may have a tendency to build up deposits and lose capacity or require frequent maintenance, particularly when crossings are located in sharp bends or streams with high sediment loads.
- E. Culverts shall be designed so that there is minimal backwater effect at all flows up to the 4% storm discharge. Energy management and sediment transport continuity shall be checked.

5605.8 Below Grade Stream Crossings

- A. Below grade stream crossings primarily include utility pipelines. Crossings should generally be at riffles and grade control structures constructed at the riffle, in addition to or constructed integrally with any encasement of the line the utility may require.
- B. If riffle crossing is not feasible, the crossing should be in a pool that is protected by a downstream grade control structure. The top of crossing elevation should be at least two feet below the top of grade control. Crossings under pools should not be armored directly, but are protected by downstream grade control.
- C. Below grade crossings shall be perpendicular to the stream whenever possible. If a perpendicular crossing is not feasible, the grade control protecting the crossing shall be perpendicular.
- D. Constriction or alteration of the pre-existing channel shape shall be avoided. If alteration occurs, sediment transport continuity and energy management shall be verified. Stream banks shall be repaired using vegetative methods whenever possible and the hydraulic roughness of the repaired stream bank should match that of the undisturbed stream banks.

5605.9 Grade Control

- A. Where grade control structures are required, they shall be placed in locations where the stream bed profile will support the creation or continuance of a riffle. The flow line of the grade control shall match the existing riffle.
- B. Where stream slope is less than 2%, the Newberry-style grade control structure detailed in Figure 5605-6 is recommended. Structures shall be constructed from durable stone sized using USACE methodology for steep channels (USACE EM 1110-2-1601, page 3-8, Equation 3-5). Rock shall generally comply with USACE gradations as given in (USACE EM 1110-2-1601, Hydraulic Design of Flood Control Channels, Chapter 3). Shotrock with sufficient fines to fill voids may be used. The use of filter fabric and uniform gradations of stone are discouraged in stream beds.
- C. Where grades are in excess of 2%, low-drop step structures should be used.
- D. Alternate styles of grade control may be approved by the City/County Engineer. Guidance for grade control design is given in Thomas et.al.
- E. Construction of new grade controls structures may be waived by the City/County Engineer if it is determined that existing riffles are adequate to prevent or retard advancing head cuts, or if it is preferable to accept the risk of future head cut than to further disturb the channel.
- F. When grade control is not part of a larger project, energy management and sediment continuity checks are not required.

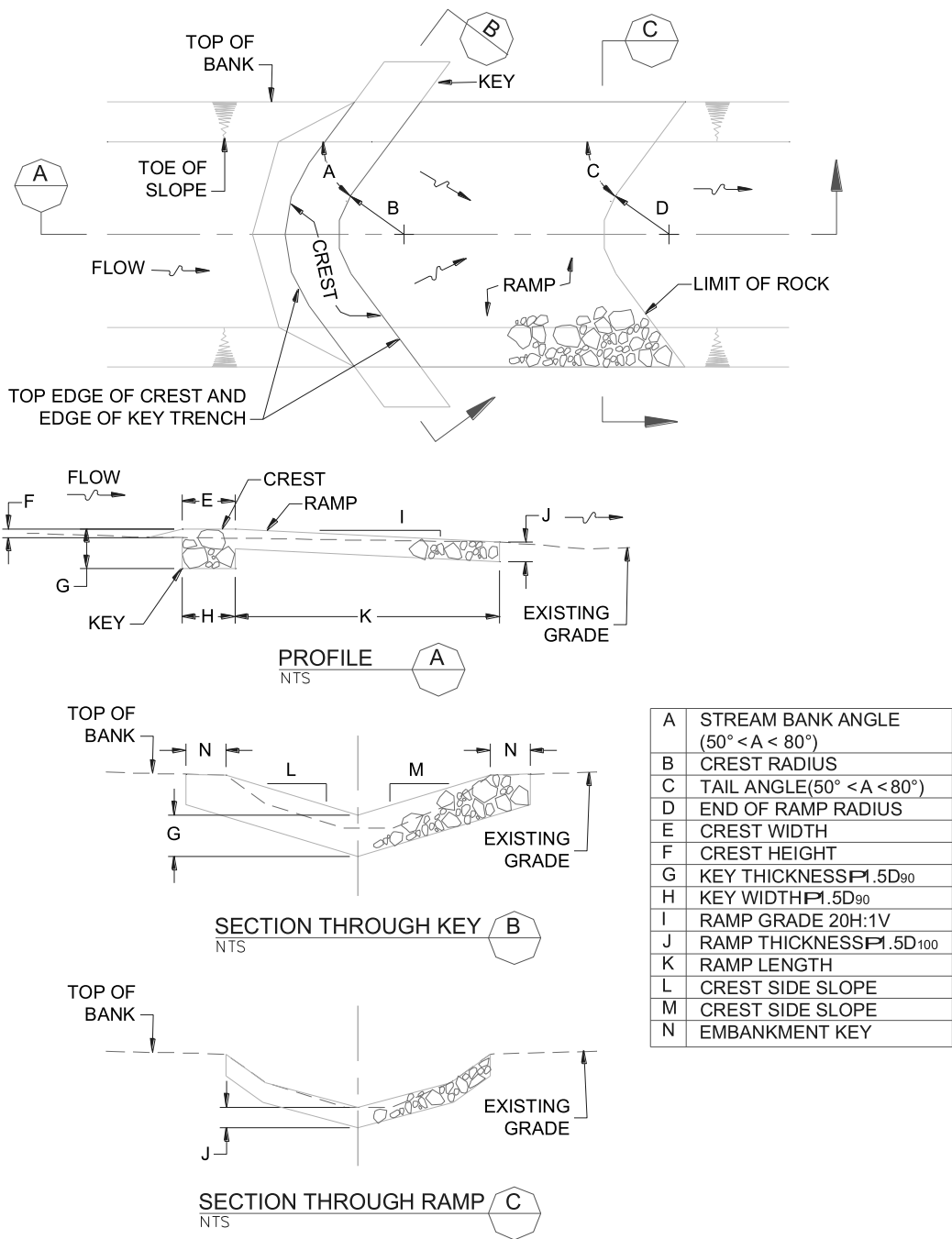

Notes

1. The depth of key trench shall be a minimum of $1.5 D_{90}$. The crest shall slope downward from the stream bank to the center of the structure to focus the flow to the channel center. The tail ramp is generally sloped at 20 horizontal to 1 vertical and dissipates energy gradually over its length. The upstream face is not perpendicular to the flow but has an upstream oriented "V" or arch shape in plan form.
2. For item A, Stream Bank Angle, and item C Tail Angle, the lower end of the range should be used for softer soils.
3. For items L and M, crest angle, the typical range is 5 to 1 to 10 to 1.

Figure 5605-6: Grade Control Structure

5605.10 Floodplain Fills:

No fill shall be placed within the bank-full floodplain, nor should fill be placed within the designated buffer zone. Fill placed outside these limits shall not cause a rise in the floodplain of the 1% ultimate conditions storm beyond the limits of the property controlled by the developer, unless authorized by the City/County Engineer. Fills placed within floodplain designated as a special flood hazard area by FEMA shall conform to FEMA and community floodplain management requirements. Energy management and sediment transport continuity shall be checked.

5605.11 Flood Control Projects:

- A.** The flood control projects that increase conveyance capacity in natural streams should generally be limited to cases where existing buildings or infrastructure face significant damage or life and safety issues. Projects to lower floodplain elevations to facilitate new development near streams at lowered elevations should be avoided.
- B.** The portion of the channel within the bank-full floodplain should be left undisturbed if possible, with conveyance increases primarily from excavation of a larger cross sectional area in the over-bank. Excavated areas within the buffer zone should be revegetated with dense, native-type vegetation. Reducing roughness in the over-bank by paving or mowing to increase velocities should be avoided.
- C.** If adequate conveyance cannot be provided using the methods above, then excavation of the over-bank below the bank-full floodplain and/or reduction in over-bank roughness may be necessary. Energy management and sediment continuity should be checked. Effort should be made to avoid direct widening of the active channel at low flows and to minimize disturbance of the active channel and nearest adjacent stream-side vegetation.

5605.12 Bank Stabilization Projects

- A.** Bank stabilization projects should generally be limited to cases where existing buildings or infrastructure face significant property damage or safety issues. Projects to stabilize banks to facilitate reductions in buffer widths for new construction should be avoided.
- B.** Prior to stabilization, the causes of the instability should be considered, including the stream's current phase of channel evolution (Interagency, 2001, Chapter 7) and direction of meander migration. Stabilization may be unnecessary if a channel has ceased incision and widening and is in the process of deposition and restoration. If stability issues appear widespread or complex, a systematic evaluation of the stream system by professionals with expertise in river engineering and fluvial geomorphology may be justified.
- C.** Instability caused by geotechnical failure (slumping of banks due to weak soils in the adjacent slopes) shall be distinguished from fluvial failure (erosion of banks caused by stream flows). For geotechnical issues, a geotechnical engineer shall evaluate the slope stability. Geotechnical designs shall provide for a 1.5 factor of safety (ratio of theoretical resisting forces to driving forces) against slope failure where it would endanger buildings, roadways, or other infrastructure, unless a lower factor of safety is approved by the City/County Engineer.
- D.** Bank stability projects should have a design life greater than the useful life of the facility being protected, or a life cycle cost analyses shall be performed that considers replacement and repair over the entire protection period. Responsible parties for future maintenance should be identified.
- E.** Stabilization should begin and end at stable locations along the bank. Bank stabilization should be limited to areas of potential erosion and are rarely required on the inside of bends. For long projects, stabilization may alternate from side to side and is rarely necessary across an entire cross section. The existing cross section should be mimicked to the extent practical and need not be planar or uniform over the entire length. Grade control shall be provided at the riffle both upstream and downstream of the stabilization to isolate it from the surrounding stream and protect the foundation from undercutting. Control at intermediate points

for longer projects may also be required. Energy management and sediment transport continuity shall be checked, and energy dissipation provided if necessary.

- F. "Hard-Armor" projects are those projects that use rip-rap, placed stone, gabions, retaining walls, or other rigid structures to provide geotechnical and fluvial stability. Such projects shall be designed in accordance with EM 1110-2-1205 (USACE, 1989), EM1110-2-1601 (USACE, 1994), or HEC-11 (FHWA 1989). Materials shall be sized to prevent dislodgement in the 1% storm. Gradation should comply with USACE or FHWA recommendations. Stones should be placed to maintain roughness and variations. All material shall be well placed to ensure interlock and stability. Materials shall be keyed into the bed and banks with adequate allowance for scour along the toe and the structure should have adequate foundation. Vertical walls should be avoided when possible as they tend to concentrate scour at their toe and are typically smoother than the natural channel.
- G. Soil bioengineering involves the use of living vegetation in combination with soil reinforcing agents such as geogrids to provide bank stabilization by increasing soil shear resistance, dewatering saturated soils, and by reducing local shear stresses through increased hydraulic roughness.
 - 1. Bio-engineering projects shall be designed in accordance with the principals of NRCS (1996) and Gray and Sotir (1996). Designs will be tailored to the urban environment by consideration of the requirement for immediate functionality upon construction, the extreme variability and high shear stress of urban flows and the availability of mechanized equipment and skilled operators.
 - 2. Selection of plants and specifications for planting methods and soil amendments shall be prepared by a professional competent in the biological and stabilization properties of plants.
 - 3. Plants selected shall be appropriate to local conditions and shall be native varieties to the greatest extent practical. Evaluation of local conditions includes assessment of site microclimate, bank slope, soil composition, strength and fertility, type and condition of existing vegetation, proximity to existing infrastructure, soil moisture conditions and likelihood of wildlife predation. Engineering factors influencing plant selection include frequency, height and duration of inundation, near-bank shear stress, size and volume of bed load as well as depth and frequency of scour.
 - 4. Plants may be either locally harvested or purchased from commercial nurseries. When harvesting, no more than 10% of a given stand may be removed and no plant on the state rare or endangered species list may be harvested or damaged in harvesting operations. Plant material grown near the metropolitan area is adapted to local climatic conditions and is preferred over more remote sources. Some species such as red maple are particularly sensitive to locale and may only be used if locally available. Seed, plant plugs, rhizomes, whips, live stakes, bare root and container stock may be used. Turf grasses, noxious or invasive species shall not be used. A variety of plant species shall be used to provide greater reliability to a design. For critical functions such as protection from toe scour a minimum of three species should generally be employed.
 - 5. Soil bioengineering methods are properly applied in the context of a relatively stable stream system, and relevant general requirements for all stream bank stabilization projects given in this section apply to bio-engineered projects. Soil bioengineering alone is not appropriate when the zone of weakness lies below the root zone of the plantings, or when rapid drawdown can occur, such as in a spillway or dam embankment.
- H. Composite methods are those which employ both hard armor and soil bioengineering. Typically, armor for toe protection in critical locations is provided, with soil-bioengineering for the remainder. Design principles for both hard armor and soil-bioengineering shall be observed as appropriate.
- I. In-stream Stability Structures: In-stream structures are used to focus flow, control grade, dissipate energy and selectively lower near-bank stress. Stream barbs, weirs, guide vanes, vegetative sills, longitudinal peak stone, and grade controls are among the more commonly used in-stream structures. When constructed of natural material such as rock, such structures also create aquatic habitat. They may be

used alone or in combination with hard armor, bioengineering or composite methods. In-stream structure design is a river engineering practice and is beyond the scope of this standard. Preliminary guidance and references for the design of some common structures is given in Castro (1999) and Interagency (2001), Chapter 8 and Appendix A.

5605.13 Stream Restoration

Restoration of urban streams is defined as the re-establishment of natural channel geometry, materials and vegetative buffers with the intent of restoring natural geometry and functions to streams that have been disturbed or eliminated. While there are significant potential ecological and quality of life benefits from stream restoration, successful design is data-intensive and requires an interdisciplinary approach. Design of stream restoration projects is beyond the scope of this standard. Interagency (2001) describes the general procedures, benefits, and requirements of stream restoration.

5605.14 Comprehensive Stream Management:

The standards set forth in preceding sections provide a moderate degree of mitigation for potential damages from individual construction projects in streams of average stability. For more sensitive streams or to obtain a greater degree of protection, Cities or Counties may elect to implement comprehensive strategies for stream management. Such strategies should be based on specific investigations of the particular streams and watersheds in the city and consider local geology, geography, climate, and ecology. Strategies may include optimized or county stream buffers (see section 5605.3), hydrology controls, and comprehensive grade control. Detailed requirements for such studies and strategies are beyond the scope of this standard, and should be developed in consultation with professionals competent in river engineering and fluvial geomorphology. The following general recommendations may be considered:

- A. Hydrology Controls for Channel Protection:** Channels respond to changes in flow volumes and recurrence by altering width, depth, velocity, suspended load, meander radius, wavelength and pool and riffle. Avoiding significant changes in flow volume and recurrence should reduce the likelihood of major changes in stream form. Volume control may include practices that encourage infiltration, evapotranspiration, and short-term detention or retention. A successful strategy would require limitations on volume, duration and magnitude of post development discharges at a number of discharge points, including common storms such as the 100% storm. The tail of hydrographs would probably need to mimic groundwater base flow. The cumulative effect of multiple detention/retention structures on duration of high flows would be considered. The impact of large impoundments or retention lakes on trapping sediment and interrupting sediment transport would be considered. Volume control for channel protection would likely require significantly different control requirements than traditional detention practices that focused primarily on flood control from extreme events.
- B. Grade Control:** In watersheds subject to deep, rapid, and extensive incision or downcutting, a comprehensive program of controlling bed elevation (grade control) may be the most practical method of preserving stream function and avoiding future bank stability concerns. Streams with easily eroded soils and lacking in shallow bedrock are highly susceptible to extensive degradation. Existing and proposed crossing points such as culverts, bridges, and encased underground utilities should be incorporated into the program. Selection of grade elevations would be based on historical data, flooding or space constraints, restoration of wetlands and streambank hydrology, channel depths, and other relevant data.

Project: _____

Stream Name and Location: _____

Evaluated by: _____ Firm: _____ Date: _____

Table 5605-4: Channel Condition Scoring Matrix

(adapted from Johnson, et al 1999)

Stability Indicator	Good (1)	Fair (2)	Poor (3)	Score (S)	Weight (W)	Rating S*W= (R)
Bank soil texture and coherence	cohesive materials, clay (CL), silty clay (CL-ML), massive limestone, continuous concrete, clay loam (ML-CL), silty clay loam (ML-CL), thinly bedded limestone	sandy clay (SC), sandy loam (SM), fractured thinly bedded limestone	non-cohesive materials, shale in bank, (SM), (SP), (SW), (GC), (GM), (GP), (GW)		0.6	
Average bank slope angle	slopes \leq 2:1 on one or occasionally both banks	slopes up to 1.7:1 (60°) common on one or both banks	bank slopes over 60° on one or both banks		0.6	
Average bank height	less than 6 feet	greater than 6 and less than 15 feet	greater than 15 feet		0.8	
Vegetative bank protection	wide to medium band of woody vegetation with 70-90% plant density and cover. Majority are hardwood, deciduous trees with well-developed understory layer, minimal root exposure	narrow bank of woody vegetation, poor species diversity, 50-70% plant density, most vegetation on top of bank and not extending onto bank slope, some trees leaning over bank, root exposure common	thin or no band of woody vegetation, poor health, monoculture, many trees leaning over bank, extensive root exposure, turf grass to edge of bank		0.8	
Bank cutting	little to some evident along channel bends and at prominent constrictions, some raw banks up to 4 foot	Significant and frequent. Cut banks 4 feet high. Root mat overhangs common.	Almost continuous cut banks, some over 4 feet high. Undercut trees with sod-rootmat overhangs common. Bank failures frequent		0.4	
Mass wasting	little to some evidence of slight or infrequent mass wasting, past events healed over with vegetation. Channel width relatively uniform with only slight scalloping	Evidence of frequent and significant mass wasting events. Indications that higher flows aggravated undercutting and bank wasting. Channel width irregular with bank scalloping evident	Frequent and extensive mass wasting evident. Tension cracks, massive undercutting and bank slumping are considerable. Highly irregular channel width.		0.8	

Table 5605-4: Channel Condition Scoring Matrix
(adapted from Johnson, et al 1999)

Stability Indicator	Good (1)	Fair (2)	Poor (3)	Score (S)	Weight (W)	Rating S*W= (R)
Bar development	narrow relative to stream width at low flow, well-consolidated, vegetated and composed of coarse bed material to slight recent growth of bar as indicated by absence of vegetation on part of bar	Bar widths wide relative to stream width with freshly deposited sand to small cobbles with sparse vegetation	Bar widths greater than ½ the stream width at low flow. Bars are composed of extensive deposits of finer bed material with little vegetation		0.6	
Debris jam potential	slight – small amounts of debris in channel. Small jams could form	moderate – noticeable debris of all sizes present	significant – moderate to heavy accumulations of debris apparent		0.2	
Obstructions, flow deflectors (walls, bluffs) and sediment traps	negligible to few or small obstructions present causing secondary currents and minor bank and bottom erosion but no major influence on meander bend	moderately frequent and occasionally unstable obstructions, noticeable erosion of channel. Considerable sediment accumulation behind obstructions	frequent and unstable causing continual shift of sediment and flow		0.2	
Channel bed material consolidation and armoring	massive competent to thinly bedded limestone, continuous concrete, hard clay, moderately consolidated with some overlapping. Assorted sizes of particles, tightly packed and overlapped, possibly imbricated. Small % of particles < 4mm	shale in bed, soft silty clay, little consolidation of particles, no apparent overlap, moderate % of particles < 4mm	silt, weathered, thinly bedded, fractured shale, high slaking potential, very poorly consolidated, high % of material < 4mm		0.8	
Sinuosity	$1.2 \leq \text{Sinuosity} \leq 1.4$	$1.1 < \text{Sinuosity} < 1.2$	Sinuosity < 1.1		0.8	
Ratio of radius of curvature to channel width	$3 \leq R_c/W_b \leq 5$	$2 < R_c/W_b < 3,$ $< R_c/W_b < 7$	$2 < R_c/W_b,$ $R_c/W_b > 7$	5	0.8	
Ratio of pool-riffle spacing to channel width at elevation of 2-year flow	$4 \leq \text{Length}/W_b < 8$	$3 \leq \text{Length}/W_b < 4,$ $8 < \text{Length}/W_b \leq 9$	$3 < \text{Length}/W_b,$ $\text{Length}/W_b > 9,$ unless long pool or run because of geologic influence		0.8	
Percentage of channel constriction	< 25%	26-50%	> 50%		0.8	
Sediment movement	little to no loose sediment	scour and/or deposition, some loose sediment	near continuous scour and/or deposition and/or loose sediment		0.8	

TOTAL _____

Table 5605-5: Characteristics of Certain Plants for Bio-Engineering

Common Name	Botanical Name	Forms Available	Comments* (see notes below)
Sandbar willow	<i>Salix exigua</i>	Live stake, whip, bare root	Shrub willow, stoloniferous, favors granular soils, inundation and scour tolerant, requires full sun, extensive fibrous roots
Peachleaf willow	<i>Salix amygdaloides</i>	Live stake, whip, bare root	Shrub willow, stoloniferous, favors granular soils, inundation and scour tolerant, requires full sun, extensive fibrous roots
Buttonbush	<i>Cephalanthus occidentalis</i>	Live stake, whip, bare root, container	Shrub, sun or shade, stoloniferous, tolerates extended inundation, high aesthetic value, nectar source
Silky dogwood	<i>Cornus ammomum</i>	Live stake, bare root	Roots from cutting with root hormone, shade tolerant, stoloniferous, shallow, fibrous roots
Roughleaf dogwood	<i>Cornus drummondii</i>	Bare root, container	Most sun and drought tolerant dogwood, extensive fibrous roots
River birch	<i>Betula nigra</i>	Bare root, B&B	High root tensile strength, rapid establishment, high aesthetics
Black walnut	<i>Juglans nigra</i>	Bare root, B&B	Check for juglone toxicity in rest of palette, deep arching roots, buttressing effect in rock soils, canopy species
Switch grass	<i>Panicum virgatum</i>	Seed, plant plug	Deep, high tensile strength roots, aggressive, may out compete other warm season grasses, good for mesic to dry sites
Arrowwood viburnum	<i>Viburnum dentatum</i>	Bare root, container	Highly adaptable to range of soil, moisture and sun conditions, understory shrub, high aesthetic value
Little blue stem	<i>Schizachyrium scoparium</i>	Seed, plant plug, container	Deep, high tensile strength roots, adaptable to dry sites, full sun to light shade

Notes:

Stoloniferous species, those with the ability to sprout from a network of near-surface stems, are used in high stress applications to protect against toe scour. The stoloniferous species form dense colonies and quickly regenerate when damaged.

Common riparian species such as black willow, box elder, and most poplar species should not be used in soil bioengineering applications in urban areas. *Populus deltoides* (eastern cottonwood) should be used only sparingly and where deep, loam soil is present. If the site is infested with *Phragmites* spp (common reed), bamboo, *Phalaris arundinacea* (reed canary grass), and *polygonum* spp (knotweed), the design must include a plan to positively eliminate the weedy species. While plant selection is site-specific the following species have broad applicability in urban streams.

SECTION 5606 ENCLOSED PIPE SYSTEMS

5606.1 Easements

Permanent easements shall be dedicated to the City/County for operation and maintenance of the storm drainage facilities. Easement width shall not be less than 15 feet, or the outside width of the pipe or conveyance structure plus 10 feet; whichever is greater. Easements shall be centered on the pipe.

- A. **Permanent:** The City/County Engineer may require wider easements when other utilities are located within the same easement and/or when the depth of cover is greater than 4 feet.
- B. **Temporary:** Temporary construction easements of sufficient width to provide access for construction shall be acquired when the proposed work is located in areas developed prior to construction.

5606.2 Capacity

Capacity shall be determined in accordance with Section 5603. Minimum design pipe size shall be 15-inch in diameter. For partially full pipe flow, Figure 5606-1 can be used to obtain hydraulic parameters of the flow.

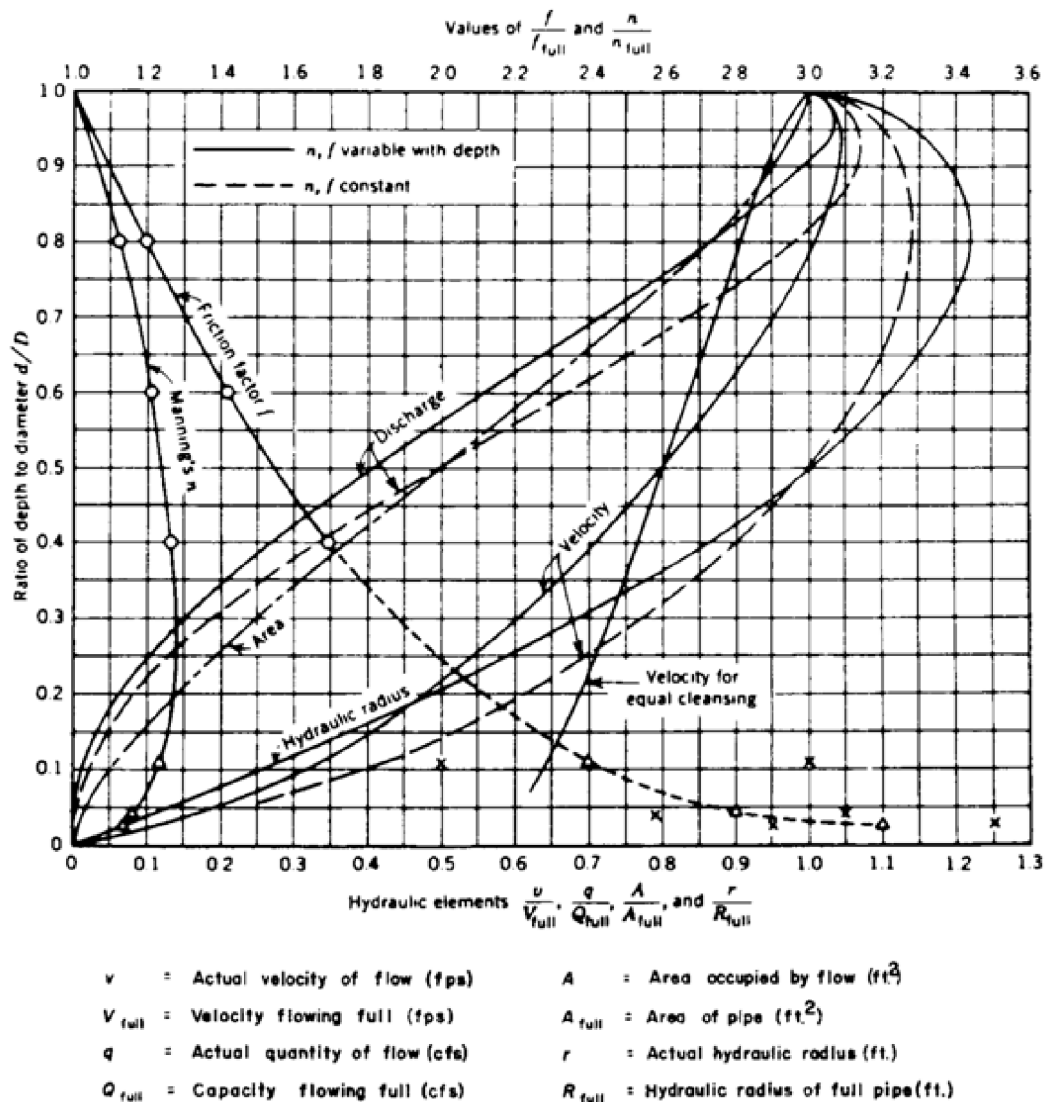

Figure 5606-1: Hydraulic Elements of Circular Conduits

5606.3 Pressure Flow

After considering the discussion presented in Section 5603.1 A, an enclosed system may be designed to operate with pressure flow, for the design storms specified in Section 5601.8, if all the following conditions are met:

- A. The Hydraulic Grade Line (HGL) must be 0.5 feet below any openings to the ground or street at all locations.
- B. Watertight joints capable of withstanding the internal surcharge pressure are used in the construction.
- C. Appropriate energy losses for bends, transitions, manholes, inlets, and outlets, are used in computing the HGL.
- D. Energy methods (Bernoulli's equation) must be used for the computations.

5606.4 Energy Dissipation:

The outfall, as defined in Section 5605.6, of all enclosed systems shall include energy dissipation sufficient to transition outlet flows to velocities and applied shear stresses consistent with the normal flow conditions in the receiving channel for the range of flows up to and including the 1% storm. Calculations, at a minimum, should include the 100%, the 10% and the 1% storms.

Energy dissipation for lateral outflows to natural streams and edge of buffer outfalls to riparian buffers shall follow the guidance in Section 5605.6. Effective energy dissipating structures shall be provided if necessary to meet the requirements stated in Tables 5605-2 and 5606-1. Examples of energy dissipating structures are:

- Check Dams
- Level Spreaders
- Hydraulic Jump Basins
- Impact Baffle Basins
- Plunge Pool and Plunge Basin
- Slotted-Grating or Slotted Bucket Dissipaters
- Stilling Basins
- Rock Revetment
- Internal Pipe Rings

Grade control shall be provided downstream of the dissipator or shall be constructed integrally with it.

The suitability of each method is site dependent and subject to approval by the City/County Engineer. Table 5606-1 lists methods and applicability.

Table 5606-1: Energy Dissipation Counter Measures

Counter Measure	Functional Applications		Suitable Environment			References
	Vertical Control	Horizontal Control	Dam Outlets	Small Culverts	Large Culvert	
Check Dam	X	O	X	X	X	2, 6
Level Spreaders	X	X	O	X	O	1
Hydraulic Jump Basins	X	X	X	X	X	1, 3
Impact Baffle Basins	X	X	X	X	X	1
Plunge Pool & Plunge	X	O	X	X	X	1

Table 5606-1: Energy Dissipation Counter Measures

Counter Measure	Functional Applications		Suitable Environment			References
	Vertical Control	Horizontal Control	Dam Outlets	Small Culverts	Large Culvert	
Basin						
Slotted-Grating or Slotted Bucket Dissipators	X	X	X	O	X	1
Stilling Basins	X	O	X	X	X	1, 2, 3, 4, 5, 6
Rock Revetment	X	X	X	X	X	1, 2, 6
Internal Pipe Rings	X	O	N/A	X	N/A	

LEGEND

- X = Suitable Countermeasure
- O = Marginal Countermeasure

REFERENCES

1. Design of Small Dams 1987 United States Department of Interior
2. HEC 23
3. Hydraulic Design of Stilling Basins and Energy Dissipaters
4. HEC-14 FHWA Hydraulic Design of Energy Dissipaters for Culverts and Channels
5. U.S. Army Corps ff Engineers, 1994 Hydraulic Design of Flood Control Channels
6. Hydraulic Design Series (HDS-6)

NOTE: Other means may be used for Energy Dissipation and Stream Stability by designers as accepted by the local governing agency.

Energy dissipaters shall be designed according to the criteria and procedures defined in professionally acceptable references. Several such references include:

- United States. Department of the Interior. Bureau of Reclamation. Design of Small Dams. 1987 ed. Denver: GPO, 1987.
- United States. Department of the Interior. Bureau of Reclamation. A Water Resource Technical Publication. Engineering Monograph No. 25. Hydraulic Design of Stilling Basins and Energy Dissipaters. 1978 ed. GPO, 1978.
- Federal Highway Administration (FHA), 1983. Hydraulic Design of Energy Dissipaters for Culverts and Channels, Hydraulic Engineering Circular (HEC) No. 14.
- US Army Corps of Engineers, 1994. Hydraulic Design of Flood Control Channels, US Army Corps of Engineers Engineer Manual EM 1110-2-1601.
- Bridge Scour and Stream Instability Countermeasures Experience, Selection, and Design Guidance (Latest Edition), National Highway Institute, HEC No. 23.
- River Engineering for Highway Encroachments, Highways in the River Environment, U.S. Department of Transportation, Federal Highway Administration, Publication No. FHWA NHI 01-004, December 2001.

5606.5 Velocity within the System

The velocity within the system shall be between 3 and 20 feet per second.

5606.6 Loading

- A. Cover:** Minimum depth of cover shall be 18 inches.
- B. Minimum Loading Conditions:**
 - 1. Live load: H-20.
 - 2. Unit Weight of soil cover: 120 lbs/ft³.
 - 3. Rigid pipes shall be bedded and backfilled to provide a minimum factor of safety of 1.5 at the 0.01-inch crack loading condition.

SECTION 5607 ENGINEERED CHANNELS

5607.1 Introduction

The criteria in this section apply to open channels that are not natural. Natural channels are covered in Section 5605. New buffers and filter strips are not required because engineered channels are strictly for conveyance.

5607.2 Easements

Permanent easements shall be dedicated to the City/County for operation and maintenance of open channels that will be publicly maintained.

- A. Engineered Channels:** Easements shall be as wide as the top of bank width; plus 10 feet on each side. Easements shall be continuous between street rights-of-way. When an improved channel begins or ends at a point other than the right-of-way of a dedicated street, a 15-foot or wider easement graded so as to permit access by truck shall be dedicated from the end of the channel to a street right-of-way. These are minimum requirements.

Generally, easements shall be required for swales that collect stormwater runoff from more than two acres or as required by the City/County.

- B. Roadside Channels:** Roadside ditches are engineered channels that are located wholly or partly within the street right-of-way. Roadside ditches in the street right-of-way do not require an easement. Otherwise, roadside ditches shall have a dedicated easement from the street right-of-way extending to five feet outside of the top of the outside bank of the channel.

5607.3 Freeboard

Freeboard shall not be required above the design headwater pool elevation at culvert entrance.

5607.4 Channel Linings

- A.** Minimum lining height shall be the selected design storm water profile plus at least a 0.5-foot freeboard.
- B.** All channel linings, except turf, shall contain provision for relieving back pressures and water entrapment at regular intervals.
- C.** Lining height on the outside bend of curves shall be increased by:

$$y = \frac{D}{4}$$

Where:

y = Increased vertical height of lining in feet

D = Depth of design flow in feet

Increased lining height shall be transitioned from y to zero feet over a minimum of:

- 30 × y feet downstream from the point of tangency (P.T.).
- 10 × y feet upstream from the point of curvature (P.C.).

5607.5 Lining Material

The types of lining material listed in Table 5607-1 shall be used to control damage and erosion. All riprap, grouted riprap, and gabion linings shall be designed with a filter fabric in conformance with Section 2605.2.C.2. The design of the lining material shall protect the channel for conditions up to the 1% storm. This criteria may be reduced to the 10% storm if the City/County Engineer approves and if responsibility for repair of channel linings in storms greater than 10% is clearly established.

Other types of lining materials not specifically listed in Table 5607-1 may be used when approved by the City/County Engineer.

Concrete lined open channel bottoms are prohibited, unless a waiver to this criterion is granted by the City/County Engineer.

Table 5607-1: Permissible Shear Stresses for Lining Material

Lining Category	Lining Type	Permissible Shear Stress (lbs/ft ²)	
General	Erosion Control Blankets	1.55-2.35	
	Turf-Reinforced Matrix (TRMs):	Unvegetated:	3.0
		Vegetated:	8.0
	Geosynthetic Materials	3.01	
	Cellular Containment	8.1	
	Woven Paper Net	0.15	
	Jut Net	0.45	
	Fiberglass Roving:	Single	0.60
		Double	0.85

	Straw With Net	1.45	
	Curled Wood Mat	1.55	
	Synthetic Mat	2.00	
Vegetative	Class A (see Table 5607-2)	3.70	
	Class B (see Table 5607-2)	2.10	
	Class C (see Table 5607-2)	1.00	
	Class D (see Table 5607-2)	0.60	
	Class E (see Table 5607-2)	0.35	
Gravel Riprap	25 mm	0.33	
	50 mm	0.67	
Rock Riprap	150 mm	2.00	
	300 mm	4.00	
Bare Soil	Non-Cohesive	See Figure 5607-1	
	Cohesive	See Figure 5607-2	

Table 5607-2: Classification of Vegetal Covers as to Degree of Retardance

Retardance Class	Cover	Condition
A	Weeping Love Grass	Excellent stand, tall (average 760 mm)
	Yellow Bluestem Ischaemum	Excellent stand, tall (average 910 mm)
B	Kudzu	Very dense growth, uncut
	Bermuda Grass	Good stand, tall (average 300 mm)
	Native Grass Mixture (little bluestem, bluestem, blue gamma, and other long and short Midwest grasses)	(Good stand, unmowed)
	Weeping lovegrass	Good stand, tall (average 610 mm)
	Lespedeza sericea	Good stand, not woody, tall (average 480 mm)
	Alfalfa	Good stand, uncut (average 280 mm)
	Weeping lovegrass	Good stand, unmowed (average 330 mm)
	Kudzu	Dense growth, uncut
C	Blue Gamma	Good stand, uncut (average 280 mm)
	Crabgrass	Fair stand, uncut 250 to 1200 mm
	Bermuda grass	Good stand, mowed (average 150 mm)
	Common Lespedeza	Good stand, uncut (average 280 mm)
	Grass-Legume mixture – summer (orchard grass, redtop, Italian ryerass, and common lespedeza)	(Good stand, uncut (150 to 200 mm)
	Centipede grass	Very dense cover (average 150 mm)
D	Kentucky Bluegrass	Good stand, headed (150 to 300 mm)
	Bermuda grass	Good stand, cut to 60-mm height
	Common Lespedeza	Excellent stand, uncut (average 110 mm)
	Buffalo grass	Good stand, uncut (80 to 150 mm)
	Grass-legume mixture—fall, spring (orchard grass, redtop, Italian, ryegrass, and common lespedeza)	(Good stand, uncut (100 to 130 mm)
E	Lespedeza sericea	After cutting to 50-mm height. Very good stand before cutting
	Bermuda grass	Good stand, cut to height 40-mm
	Bermuda grass	Burned stubble

Note: Covers classified have been tested in experimental channels. Covers were green and generally uniform.

Figure 5607-1: Permissible Shear Stresses for Non-Cohesive Soils

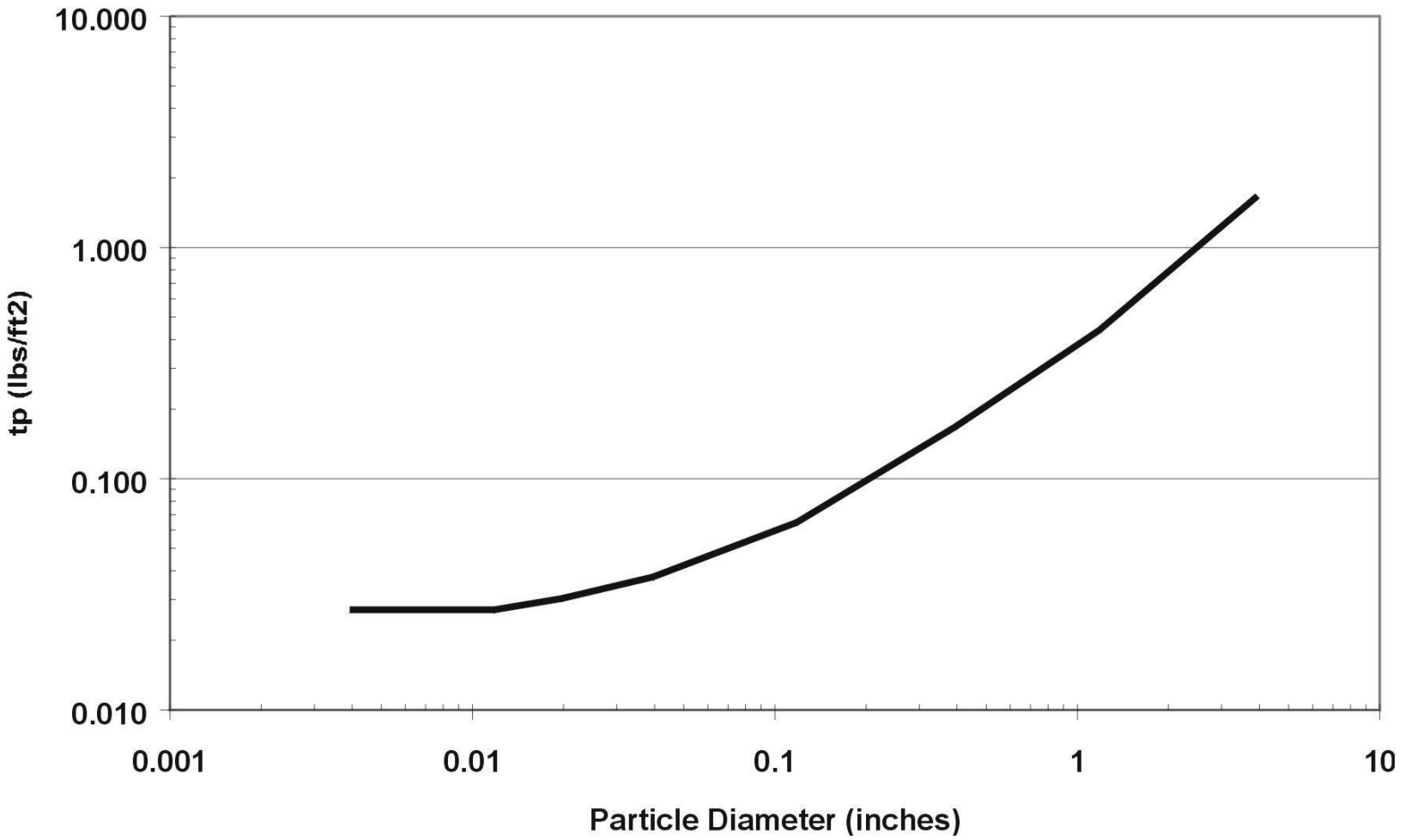
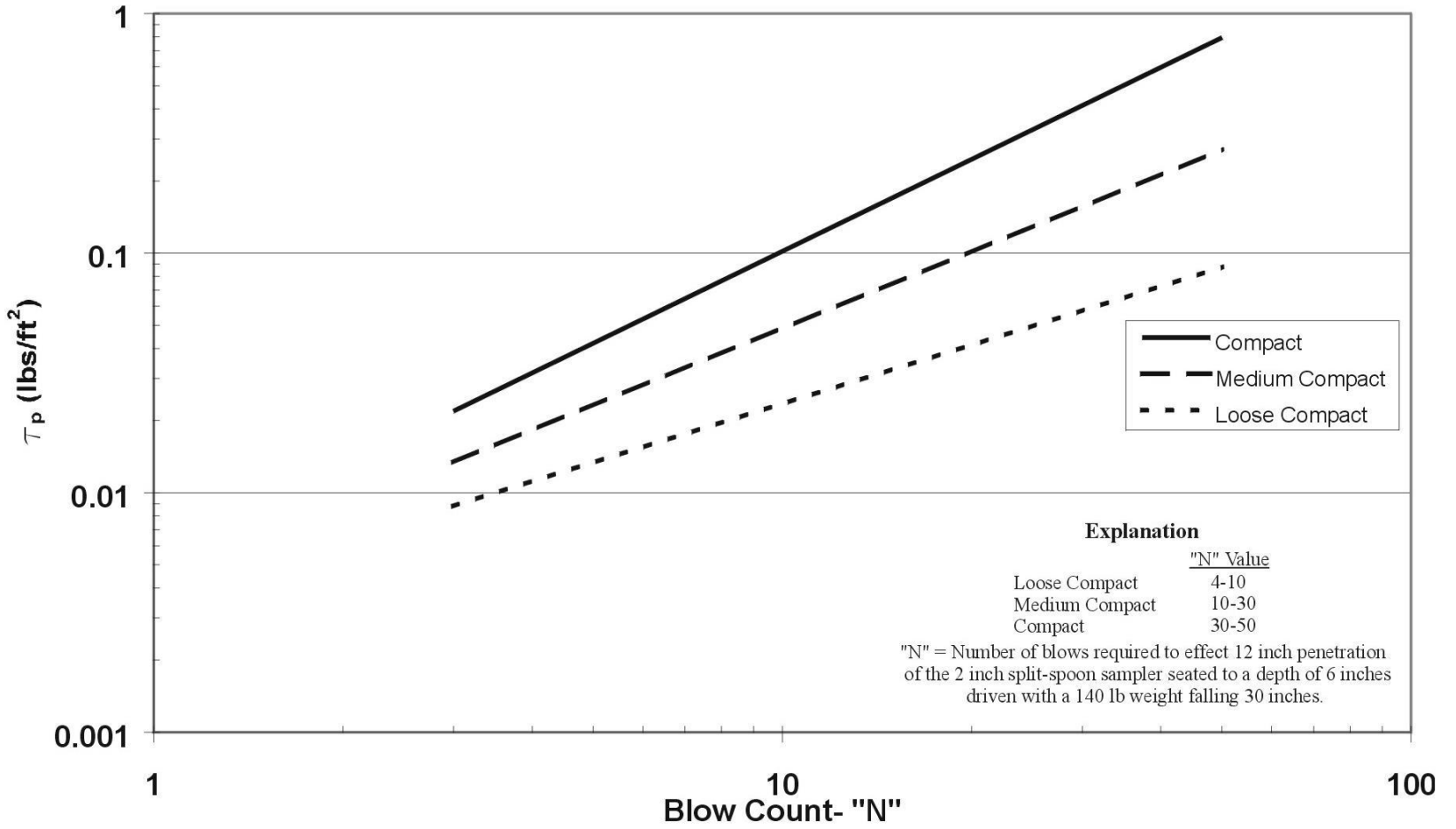

Figure 5607-2: Permissible Shear Stresses for Cohesive Soils



5607.6 Side Slopes

- A. Side slopes shall not be steeper than:
 - 1. 3 horizontal to 1 vertical for turf lining.
 - 2. 2.5 horizontal to 1 vertical for all other lining materials, unless a geotechnical analysis indicates a steeper slope can be used.
 - 3. Flatter if necessary to stabilize slopes.

5607.7 Alignment Changes

Alignment changes shall be achieved by curves having a minimum radius of:

$$R = \frac{V^2 \cdot W}{8D}$$

Where:

- R = Minimum radius on centerline in feet
- V = Design velocity of flow in feet per second
- W = Width of channel at water surface in feet
- D = Depth of flow in feet

5607.8 Vertical Wall Channels

- A. Vertical walls may be used for structural lining of improved channels when site conditions warrant; subject to the following special requirements:
 - 1. Walls shall be designed and constructed to act as retaining walls.
 - 2. Adequate provisions shall be made for pedestrian entry/exit from the channel.

5607.9 Energy Management

- A. Use of grade control structures can be used to manage boundary shear.
- B. Energy dissipation structures should be designed in accordance with Section 5606.

SECTION 5608 STORMWATER DETENTION AND RETENTION

5608.1 Scope

This section governs the requirements and design of stormwater detention and retention facilities.

5608.2 Access and Easements

Permanent access and buffers must be provided for maintenance of a detention facility with the following minimum requirements:

- A. The water surface of the design storage pool shall be a minimum of 20 feet from property lines and building structures. A greater distance may be necessary when the detention facility might compromise foundations or slope stability is a consideration.
- B. A 15 foot wide access strip, with slopes less than 5 horizontal to 1 vertical, shall be provided around the perimeter of the facility, unless it can be demonstrated that all points of the facility can be maintained with less access provided.
- C. The property owner shall also maintain a minimum 15 foot wide access route to the detention facility from a street or parking lot with slopes no greater than 5:1 in any direction.
- D. Structures, inlet pipes, outlet pipes, spillways, and appurtenances required for the operation of the facility shall also be provided access which is no less than easement widths established in Sections 5606.1 and 5607.2.

Easements are frequently not required for detention facilities, because a detention facility is typically maintained by the property owner. If the detention facility is not maintained by the property owner or involves multiple ownerships, easements must be dedicated to the party responsible for maintenance. At a minimum the dedicated easements shall include: 1) the detention pond per se, which extends to the design storage pool elevation and the toe of the embankment slope; 2) appurtenances; and 3) access required by items B through D above.

5608.3 Maintenance and Continued Performance

Maintenance responsibility for all elements of the detention facility should be designated prior to construction of any detention facility. However, when no designation is made the property owner shall be considered the responsible party. Annual or more frequent inspections shall be made by the responsible party to assure that all inlet and outlet structures are fully functional and the detention basin has full storage capacity.

5608.4 5608.4 Performance Criteria

A. General Provisions

1. Detention/retention facilities shall have 1,000 acres or less area tributary to the facility.
2. Dams which are greater than 10 feet in height but do not fall into State or Federal requirement categories shall be designed in accordance with latest edition of SCS Technical Release No. 60, "Earth Dams and Reservoirs", as Class "C" structures.
3. All lake and pond development must conform to local, state, and federal regulations. Legal definitions and regulations for dams and reservoirs can be found in the Missouri Code of State Regulations, Division 22, and the State of Kansas Rules and Regulations, KSA 82a-301 through 305a.

B. Computational Methods

1. Time of Concentration and Travel Time: Refer to Section 5602 for acceptable hydrology methods.
2. Temporary Storage Volume: A preliminary value of the storage requirement may be obtained through methods outlined in (SCS, 1986, Chapter 6) or other acceptable methods. The storage shall be checked during routing of design hydrographs through the basin and adjusted appropriately.

3. Hydrograph Routing: The storage indication method (Modified Puls) of routing a hydrograph through a detention basin may be utilized. Reference: (Chow, 1964). Under the Comprehensive and Frequent Event Strategies, the water quality orifice is designed to store the water quality storm and drain it within 40 hours. Routing of the other larger storms is then done independently, assuming the water quality storm is not present, but using the water quality orifice as part of the rating curve.

C. Release Rates: The maximum release rate from any development under the runoff control strategies outlined in Section 5601.5.A-4 shall be as follows:

1. Comprehensive Control

- a. Post-development peak discharge rates from the site shall not exceed those indicated below:
 - 50% storm peak rate less than or equal to 0.5 cfs per site acre
 - 10% storm peak rate less than or equal to 2.0 cfs per site acre
 - 1% storm peak rate less than or equal to 3.0 cfs per site acre
- b. 40-hour extended detention of runoff from the local 90% mean annual event (1.37"/24-hour rainfall). See Chapter 6 of the MARC/APWA BMP Manual for calculating this volume.

2. Frequent Event Control

- a. Post-development peak discharge rates from the site shall not exceed those indicated below:
 - 50% storm peak rate less than or equal to 0.5 cfs per site acre
 - 10% storm peak rate less than or equal to 2.0 cfs per site acre
- b. 40-hour extended detention of runoff from the local 90% mean annual event (1.37"/24-hour rainfall). See Chapter 6 of the MARC/APWA BMP Manual for calculating this volume.

3. Extreme Flood Event Control

- a. Post-development peak discharge rates from the site shall not exceed those indicated below:
 - 10% storm peak rate less than or equal to 2.0 cfs per site acre
 - 1% storm peak rate less than or equal to 3.0 cfs per site acre

Note: If known flooding occurs downstream in flood events more frequent than the 1% event, the local authority may require control of these events.

D. Detention Basin Size

1. Owners/engineers may utilize methodology outlined in (SCS, 1986). A 24-hour Type II rainfall distribution shall be the required storm hyetograph. Hydrologic simulation models shall be based on not less than Antecedent Moisture Condition II (see Section 5602.2). Maximum detention storage shall be based upon the allowable release rate and upon the developed condition for the site. Cities and Counties may establish additional standards for other storm sizes in order to provide stream channel and water quality protection.

2. **Detention Storage Reduction with Upstream BMPs:** When volumetric control BMPs are implemented on a site, the volume captured by these BMPs may be deducted from the site detention volume required for the 90% mean annual event under the "Frequent Event" and "Comprehensive" control designs. Volumetric BMPs are defined as those BMPs in the MARC/APWA BMP Manual that infiltrate or provide 40-hour extended detention of the 90% mean annual event runoff (or water quality volume, WQ_v). Volumetric BMPs (per Chapter 4 of the MARC/APWA BMP Manual) include:

- Bioretention

- Rain gardens
 - Infiltration basins and trenches
 - Bio-swales and wetland swales
 - Extended detention facilities (including wetlands)
 - Permeable pavement
- E. Primary Outlet Works:** The primary outlet shall be designed to meet the following requirements:
1. The outlet shall be designed to function without requiring attendance or operation of any kind or requiring use of equipment or tools, or any mechanical devices.
 2. All discharge from the detention facility when inflow is equal to or less than the maximum design storm under the required Strategy shall be via the Primary outlet system.
 3. The design discharge rate via the outlet shall continuously increase with increasing head and shall have hydraulic characteristics similar to weirs, orifices or pipes.
 4. For dry detention basins not providing extended detention, the design shall allow for discharge of at least 80 percent of the detention storage volume within 24 hours after the peak or center of mass of the inflow has entered the detention basin.
 5. Ponds shall be designed with a non-clogging outlet such as a reverse-slope pipe, or a weir outlet with a trash rack. A reverse-slope pipe draws from below the permanent pool extending in a reverse angle up to the riser and establishes the water elevation of the permanent pool. Because these outlets draw water from below the level of the permanent pool, they are less likely to be clogged by floating debris.
 6. All openings shall be protected by trash racks, grates, stone filters, or other approved devices to insure that the outlet works will remain functional. Minimum orifice size shall be per the current version MARC/APWA BMP Manual. See MARC/APWA BMP Manual Sections 8.6, 8.10 and 8.12 for design guidance and typical details for low-flow outlets and trash rack designs. Note that multiple design options are available for non-clogging low flow outlets and debris collection and designers are encouraged to select the best design for their site.
- F. Emergency Spillways:** The emergency spillway may either be combined with the outlet works or be a separate structure or channel meeting the following criteria:
1. **Elevation:** Emergency spillways shall be designed so that their crest elevation is 0.5 feet or more above the maximum water surface elevation in the detention facility attained by the maximum design storm under the required Strategy for the facility.
 2. **Capacity:** In cases where the impoundment/emergency spillway is not regulated by either State or Federal agencies, the emergency spillway shall be designed to pass the 1% storm with 1 foot of freeboard from the design stage to the top of dam, assuming zero available storage in the basin and zero flow through the primary outlet. This design provides an added level of protection in the event of a clogged primary outlet or a subsequent 1% storm event that occurs before the flood pool from the initial storm event recedes to the principal outlet elevation.
- G. Drawdown Provision:** Drain works consisting of valves, gates, pipes, and other devices as necessary to completely drain the facility in 72 hours or less when required for maintenance or inspection shall be provided.
- H. Erosion Control:** Primary outlet works, emergency spillways, and drain works, as well as conveyance system entrances to detention basins, shall be equipped with energy dissipating devices as necessary to limit shear stresses on receiving channels. See Tables 5605-2 and 5606-2 for shear stress criteria.

5608.5 Detention Methods:

In addition to the foregoing criteria, the following shall be applicable, depending on the detention alternative(s) selected:

- A. Wet Detention Facility:** For basins designed with permanent pools:
 - 1. **Sediment Forebay:** A sediment forebay shall be provided to trap coarse particles. Refer to the "Mid-America Regional Council and American Public Works Association; Manual for Best Management Practices for Stormwater Quality" for typical design specifications and configurations of sediment forebays.
 - 2. **Minimum Depth:** The minimum normal depth of water before the introduction of excess stormwater shall be four feet plus a sedimentation allowance of not less than 5 years accumulation. Sedimentation shall be determined in accordance with the procedures shown in Figure 5608-1.
 - 3. **Depth for Fish:** If the pond is to contain fish, at least one-quarter of the area of the permanent pool must have a minimum depth of 10 feet plus sedimentation allowance.
 - 4. **Side Slopes:** The side slopes shall conform as closely as possible to regraded or natural land contours, and should not exceed three horizontal to one vertical. Slopes exceeding this limit shall require erosion control and safety measures and a geotechnical analysis.
 - 5. 5. Refer to the MARC/APWA BMP Manual for design requirements on facilities providing control of the WQv (Comprehensive and Frequent Event Strategies).
- B. Dry Detention Facility:** For basins designed to be normally dry:
 - 1. **Interior Drainage for non-BMP basins:** Provisions must be incorporated to facilitate interior drainage to outlet structures. Grades for drainage facilities shall not be less than two percent on turf.
 - 2. **Earth Bottoms:** Earth bottoms shall be vegetated.
 - 3. **Side Slopes:** The side slopes of dry ponds should be relatively flat to reduce safety risks and help to lengthen the effective flow path. Slopes shall not be steeper than three horizontal to one vertical and at least 25% of the perimeter shall have a slope of 5 to 1 or flatter.
 - 4. Refer to the MARC/APWA BMP Manual for design requirements on facilities providing control of the WQv (Comprehensive and Frequent Event Strategies).
- C. Rooftop Storage:** Detention storage may be met in total or in part by detention on roofs. Details of such designs shall include the depth and volume of storage, details of outlet devices and down drains, elevations and details of overflow scuppers, and emergency overflow provisions. Connections of roof drains to sanitary sewers are prohibited. Design loadings and special building and structural details shall be subject to approval by the City/County Engineer.
- D. Parking Lot Storage:** Paved parking lots may be designed to provide temporary detention storage of stormwater on a portion of their surfaces. Generally, such detention areas shall be in the more remote portions of such parking lots. Depths of storage shall be limited to a maximum depth of nine inches, and such areas shall be located so that access to and from parking areas is not impaired.
- E. Other Storage:** All or a portion of the detention storage may also be provided in underground or surface detention areas, including, but not limited to, oversized storm sewers, vaults, tanks, swales, etc.

EXAMPLE:

TRIBUTARY AREA = 20 ACRES

RATIONAL METHOD RUNOFF COEFFICIENT "C" = 0.6

SEDIMENT STORAGE = 120 CU. FT. PER ACRE PER YEAR

TOTAL SEDIMENT STORAGE = 120 X 20 = 2400 CU. FT. PER YEAR.

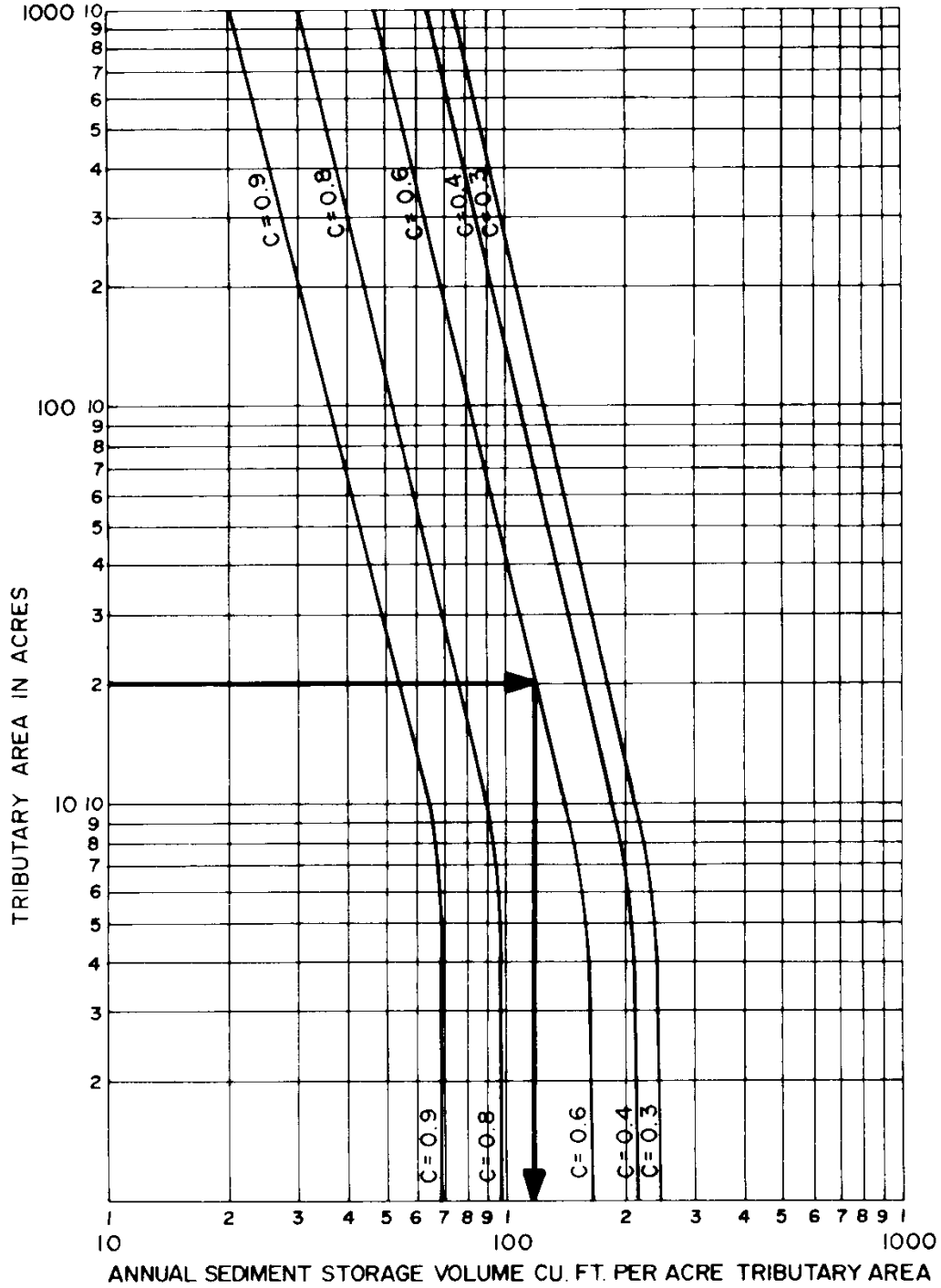

Figure 5608-1: Annual Sediment Storage

5608.6 Required Submittals:

- A. The Owner shall submit the following information and data to the City/County Engineer.
1. Elevation-area-volume curves for the storage facility including notation of the storage volumes allocated to runoff, sediment, and permanent residual water storage for other uses (wet basins only).
 2. Inflow hydrographs for all (1, 10, and 50-percent) design storms.
 3. Stage-discharge rating curves for each emergency spillway, primary outlet works and combined outlets and overflows.
 4. Routing curves for all (1, 10 and 50-percent) design storms with time plotted as the abscissa and the following plotted as ordinates:
 - Cumulative inflow volume
 - Cumulative discharge
 - Stage elevation
 - Cumulative storage
 5. Drainage Study when a waiver is requested by the Developer. See Section 5609 for minimum requirements.

5608.7 Additional Requirements

- A. **Access:** Provisions shall be made to permit access and use of auxiliary equipment to facilitate emptying, cleaning, maintenance, or for emergency purposes.
- B. **Underground Storage:** Underground detention facilities shall be designed with adequate access for maintenance (cleaning and sediment removal). Such facilities shall be provided with positive gravity outlets. Venting shall be sufficient to prevent accumulation of toxic or explosive gases.

SECTION 5609 PLAN REQUIREMENTS

5609.1 Scope

The section governs the preparation of plans for stormwater system projects.

5609.2 General

The plans shall include all information necessary to build and check the design of storm drainage systems and related appurtenances. The plans shall be arranged as required by the City Engineer of local governing agency. Applicable standard plans of the local governing agency may be included in whole or by reference.

Plans shall be sealed by a Registered Professional Engineer in the state of the City or governing agency and shall be submitted to the local governing agency for review.

5609.3 Type of Sheets in Plans

The plans shall consist of:

- Title sheet
- General layout sheets
- Plan and profile sheets
- Cross-section sheets
- Drainage area map and table
- Standard and special detail sheets
- Traffic control plans (if required)
- Temporary erosion control plans
- Grading plans (if required)
- Property line and easement sheets (if required)
- Each sheet shall contain a sheet number, including the individual sheet number and the total number of sheets, proper project identification and all revision dates. The
- Engineer's seal shall appear on the title sheet and other sheets as required by the State licensing requirements.

5609.4 Sheet Sizes

The suggested sheet size is 22 inches by 36 inches with 2 inch binding margin along the left end of the sheets. All sheets in a given set of plans shall be of the same size. Plan and profile shall be drawn on combined or separate plan and profile sheets to minimum scales indicated herein.

5609.5 Scales

Plans shall be drawn at the minimum scales indicated in Table 5609-1. Other scales may be needed to clearly present the design. Bar Scales shall be shown on each sheet for each scale.

Table 5609-1: Drawing Scales

Drawing Type	Scale
Plan	1 inch = 20 feet
Profile	
Vertical	1 inch = 5 feet
Horizontal	1 inch = 20 feet
Cross Sections	
Vertical	1 inch = 5 feet
Horizontal	1 inch = 10 feet
Drainage Area Map	
Onsite	1 inch = 200 feet
Offsite	1 inch = 1,000 feet
Structural Plans	¼ inch = 1 foot

5609.6 Required Information for Title Sheet:

- Name of project
- Project number
- Index to sheets
- A location map adequately showing the project location in relation to major streets, with north arrow and scale. Map shall be oriented with north arrow up
- A signature block for local governing agency approval
- Name, address and telephone number of the consulting engineer and owner/developer as well as signature block for the owner/developer
- A legend of symbols shall be shown that apply to all sheets
- List containing name and telephone number of each utility company and state One-Call system
- Engineer's seal, signed and dated
- Other information as per local governing agency requirements

5609.7 Required Information for General Layout Sheet:

- General Notes: Minor construction notes shall appear on the proper plans and profile sheets
- North arrow and bar scale. North arrow shall be oriented up or to the right
- Surveyed or aerial base map detail indicating existing man-made or natural topographical features, such as buildings, fences, trees, channels, ponds, streams, etc... and proposed and existing utilities
- Subdivision information including, but not limited to, rights-of-way; property and lot lines; existing and proposed easements; subdivision nomenclature; street names; and other pertinent information impacting the project
- Identification and location of all existing and proposed drainage features
- Elevation and location of all applicable benchmarks: NGVD datum or as required by local governing agency. A minimum of two (2) benchmarks are required for each project

- Survey control line or base line with adequate ties to land lines
- Locations of test borings if taken
- Existing and finish grade contours at intervals of 2.0 feet or less in elevation; or equivalent detail indicating existing and finish grades and slopes
- A uniform set of symbols subject to the approval of the local governing agency
- Addresses of homes abutting the projects, and current homeowner names associated with properties impacted by the project

5609.8 Required Information for Plan and Profile Sheets:

- North arrow and bar scale. North shall be oriented up or to the right
- Ties to permanent reference points for each system
- A uniform set of symbols subject to the approval of the local governing agency
- Existing man-made and natural topographic features, such as buildings, fences, trees, channels, ponds, streams, etc., and all existing and proposed utilities
- Identification and location of each storm drainage segment and existing utilities affecting construction
- Length, size and slope of each line or channel segment. The profile shall indicate the hydraulic grade line of the underground as well as the overland design flows
- Right-of-Way, property, easement lines and street names
- The 1 percent floodplain and setback from the top of bank of an open channel to any building
- Location of test borings
- Existing and finish grade contours at intervals of 2.0 feet or less in elevation; or equivalent detail in profiles and cross-sections indicating existing and finish grading
- Headwater elevation at the inlet end of each culvert
- Invert elevations in and out and top elevations of each structure shall be shown. At least two elevations shall be shown for inlet tops matching sloped grades
- Each utility line crossing the alignment shall be properly located and identified as to type, size and material. This information shall be to the best information available and provided through records, field prospecting and or excavation
- Test borings representing depth of drilled hole and refusal elevation if applicable
- All station and invert elevations of manholes, junction boxes, inlets and other significant structures
- The profile shall show existing grade above the centerline as a dashed line, proposed Finish grades or established street grades by solid lines; and shall show the flow line of any drainage channel, either improved or unimproved, within 50-feet of either side of centerline. Each line shall be properly identified. The proposed sewer shall be shown as double solid lines properly showing the top and bottom of pipe
- All structures shall be shown and labeled with appropriate drawing references

5609.9 Cross-Section Sheets

Cross-sections shall be drawn for all open channels. Sections shall be at appropriate intervals not greater than 50 feet. Additional cross sections shall be drawn at all structures and intersecting drainage systems. Cross sections

shall also provide for overflow drainage paths that are designated to convey overland flows in excess of underground system capacity. The following shall be indicated on each section:

- Ties from centerline to base line.
- Existing and proposed grades.
- Elevation of proposed flow-lines.
- Cut and fill end areas if required for bid quantities.

5609.10 Drainage Area Map

The drainage area map shall be supported by a drainage table tabulating the physical properties of the drainage sub-basins, as well as the hydrologic and hydraulic properties of the design. The drainage map shall have the following.

- North arrow and bar scale. North shall be oriented up or to the right.
- Drainage area boundaries for all watersheds including sub-watersheds of analysis including pass through waters, inlet drainage areas, culvert drainage areas and other points of interest..
- Drainage system nomenclature matching that on the “designed” systems shown in the plans.

5609.11 Standard and Special Detail Sheets

Detail sheets shall be included to show all details of appurtenances, materials and construction. Details shall conform to the requirements of the local governing agency and are to be drawn clearly and neatly with proper identifications, dimensions materials and other information necessary guide desired construction.

5609.12 Traffic Control Plans (if required)

Traffic control plans shall conform to design and principals contained the most recent copy of Manual of Uniform Traffic Control Devices (MUTCD).

5609.13 Temporary Erosion Control Plan Sheets

- Each temporary erosion control feature designation shall be shown in its proper location on the plans
- Temporary erosion control devices shall be detailed in the plans as necessary.
- Notes shall be included in the plans indicating that the erosion control systems shall be monitored throughout the project life and maintained and adjusted as necessary to control erosion.
- Erosion control plans shall be shown and be designed specific to each phase of development or construction.

5609.14 Grading Plan Sheets (if required)

Grading plan sheets shall be included as required by the local governing agency. The grading plans shall incorporate information concerning the changes in the land geometry to accommodate the development. It shall include but not be limited to existing and proposed contours, building elevations, curb elevations, retaining wall elevations and other information pertinent to the site.

5609.15 Property Line and Easement Sheets

Separate property line and easement sheets may be required by the local governing agency. The information on this sheet shall be sufficient to display the existing and proposed property line and easement changes relative to the project.

SECTION 5610 REFERENCES

- Alexander, T.T., and Wilson, G.L., 1995, Technique for Estimating the 2- to 500- Year Flood Discharges on Unregulated Streams in Rural Missouri: U.S. Geological Survey Water-Resources Investigations Report 95-4231, 33 p.
- Becker, L.D., 1986, Techniques for Estimating Flood-Peak Discharges from Urban Basins in Missouri: U.S Geological Survey Water-Resources Investigations Report 86-4322, 38 p.
- Castro, J., 1999 Design of Stream Barbs, USDA, NRCS, Engineering Technical Note No. 23.
- Center for Watershed Protection, Site Planning for Urban Stream Protection", <http://www.cwp.org/SPSP/TOC.htm>
- Chow, V.T., 1988. Open-Channel Hydraulics, McGraw-Hill Book Publishing Company.
- Chow, V.T., 1964. Handbook of Applied Hydrology, McGraw-Hill Book Publishing Company.
- Federal Highway Administration (FHA), 1989. Design of Rip-Rap Revetment. Hydraulic Engineering Circular (HEC) No. 11.
- Federal Highway Administration (FHA), 1983. Hydraulic Design of Energy Dissipaters for Culverts and Channels, Hydraulic Engineering Circular (HEC) No. 14.
- Federal Highway Administration (FHA), 1996. Urban Drainage Design Manual, Hydraulic Engineering Circular No. 22.
- Federal Interagency Stream Restoration Working Group, (Interagency) 1998 with Addenda 2001. Stream Corridor Restoration: Principles, Processes and Practices – Stream Corridor Restoration Handbook.
- Gray, D.H. and R.B. Sotir, 1996. Biotechnical and Soil Bioengineering Slope Stabilization, John Wiley and Sons.
- Heraty, M., Herson-Jones, L.M. and B. Jordan, 1995, Riparian Buffer Strategies for Urban Watersheds, Metropolitan Washington Council of Governments.
- Johnson, P.A., 2002. Incorporating Road Crossings into Stream and River Restoration Projects, Ecological Restoration, Vol.20, No.4.
- Johnson, P. A., G. L. Gleason, and R. D. Hey, 1999. Rapid Assessment of Channel Stability in Vicinity of Road Crossings, ASCE, Journal of Hydraulic Engineering, Vol. 125, No. 6.
- Lane, E.W., 1955. The Importance of Fluvial Morphology in Hydraulic Engineering, Proceedings of the American Society of Civil Engineers, vol. 81, no. 795, 17p.
- Leopold, L.B., M.G. Wolman, and I.P. Miller, 1964. Fluvial Processes in Geomorphology, W. H. Freeman and Co.
- McEnroe, Bruce M. and Hongying Zhao (2001). Lag Times of Urban and Developing Watersheds in Johnson County, Kansas. Report No. K-TRAN: KU-99-5, Kansas Department of Transportation.
- McEnroe, Bruce M. and Gonzalez Pablo (2002). Storm Durations and Antecedent Moisture Conditions for Flood Discharge Estimation, Kansas. Report No. K-TRAN: KU-02-04, Kansas Department of Transportation.
- National Academy of Sciences, 1999, Riparian Zones: Function and Strategies for Management, WSTB –U-98-01-A.
- Newbury, R.M., M.Gaboury and C. Watson, 1997. Field Manual of Urban Stream Restoration, Illinois Water Survey. Available from Conservation Technology Information Center, IN.
- Rasmussen, Patrick P. and Charles A. Perry (2000). Estimation of Peak Streamflows for Unregulated Rural Streams in Kansas. Water-Resources Investigations Report 00-4079, U.S. Geological Survey.
- Sauer, V.B., Thomas, W.O., Jr., Stricker, V.A, and Wilson, K.V., 1983, Flood Characteristics of Urban Watersheds in the United States: U.S. Geological Survey Water-Supply Paper 2207, 63 p.

Thomas, D.B., S.R. Abt, R.A. Mussetter, and M.D. Harvey, 2000. A Design Procedure for Step Pool Structures, Procedures Water Resources Engineering and Water Resources Planning and Management, American Society of Civil Engineers.

Urban Water Resources Research Council, 1992. Design and Construction of Urban Stormwater Management Systems, ASCE Manuals and Reports of Engineering Practice No. 77, WEF Manual of Practice, FD-20, American Society of Civil Engineers and the Water Environment Federation.

US Army Corps of Engineers, 1989. Sedimentation Investigations of Rivers and Reservoirs, US Army Corps of Engineers Engineer Manual EM 1110-2-4000.

US Army Corps of Engineers, 1989. Environmental Engineering for Flood Control Channels, US Army Corps of Engineers Engineer Manual EM 1110-2-1205.

US Army Corps of Engineers, 1993. River Hydraulics, US Army Corps of Engineers Engineer Manual EM 1110-2-1416.

US Army Corps of Engineers, 1994. Channel Stability Assessment for Flood Control Projects, US Army Corps of Engineers Engineer Manual EM 1110-2-1418.

US Army Corps of Engineers, 1994. Hydraulic Design of Flood Control Channels, US Army Corps of Engineers Engineer Manual EM 1110-2-1601.

US Army Corps of Engineers, 1998, HEC-RAS River Analysis System, Hydrologic Engineering Center.

US Army Corps of Engineers, R.R. Copeland, D.N. McComas, C.R. Thorne, P. J. Soar, M.M. Jonas and J.B. Fripp, 2001. Hydraulic Design of Stream Restoration Projects, ERDC/CHL TR-01-28.

US Department of Agriculture. 1999. Design of Streambarbs, Technical Note No. 23.

US Department of Agriculture. Forest Service. C.C. Harrelson, C.L. Rawlins, J.P. Potyondy. Stream Channel Reference Sites: An Illustrated Guide to Field Technique. Rocky Mountain Forest and Range Experiment Station, General Technical Report RM-245. 1994. Available at <http://www.stream.fs.fed.us/publications/documentsStream.html>.

US Department of Agriculture Soil Conservation Service (NRCS), 1996. Stream bank and Shoreline Protection, Chapter 16, US Department of Agriculture Soil Conservation Service Engineering Field Handbook.

US Department of the Interior, Bureau of Reclamation, 1974. Design of Small Dams, US Government Printing Office.

US Department of the Interior. Bureau of Reclamation. 1978. A Water Resource Technical Publication. Engineering Monograph No. 25. Hydraulic Design of Stilling Basins and Energy Dissipaters. GPO.

US Soil Conservation Service (SCS). June 1986 Technical Release No. 55 "Urban Hydrology for Small Watersheds", 2nd Edition.

US Soil Conservation Service (SCS). August 1981. Technical Release No. 60, "Earth Dams and Reservoirs", as Class "C" structures.

Wegner, S., 1999. A Review of the Scientific Literature on Riparian Buffer Width, Extent and Vegetation, Institute of Ecology, University of Georgia.

WEST Consultants, Inc., 1996. Riprap Design System.

Williams P.B., Swanson, M.L., 1989. A New Approach to Flood Protection Design and Riparian Management, US Department of Agriculture Forest Service General Technical Report PSW-110, pp. 40-45

APPENDIX A

Microsoft Visual Basic Function for Inlet Interception Calculations

The following is a Microsoft Visual Basic function that can be added to a Microsoft Excel (97 or later) worksheet or template for inlet intercept calculations.

```
Function InletIntercept(slope, Qt, Optional CrossSlope = 2, _
                        Optional Length = 4#, Optional CurbType = "A",
                        Optional Metric = False)
'
' InletIntercept Macro
' Determine the intercept ratio for setback curb
' inlets given length of opening, q, slope and cross slope
' All inputs in english units.
' Function written 04/19/1999 by Michael S. Ross
'
Dim a As Double, b As Double, c As Double, d As Double
Dim x As Double, Qo As Double, Qa As Double
Dim strAlert As String

CurbType = UCase(CurbType)
If CurbType <> "A" And CurbType <> "B" Then
    strAlert = "Curb type must be one of 'A' or 'B'. 'A' assumed. "
    CurbType = "A"
End If
If slope >= -0.00001 And slope <= 0.00001 Then
    InletIntercept = Qt
Else
    Select Case CurbType
    Case "A"
        Select Case CrossSlope
        Case 2
            If Metric Then
                a = -0.12
                b = 0.03
                c = 1.07
                d = 0.24
                x = -0.7
            Else
                a = -0.4
                b = 0.1
                c = 3.5
                d = 0.8
                x = -0.7
            End If
        Case 4
            If Metric Then
                a = -0.09
                b = 0.09
                c = 1.31
                d = 0.76
                x = -0.8
            Else
```

```

        a = -0.3
        b = 0.3
        c = 4.3
        d = 2.5
        x = -0.8
    End If
Case Else
    strAlert = strAlert & "Cross slope must be either 2% or 4%," &
-
-           "other cross slopes were not modelled. Assuming 2%."
"

    If Metric Then
        a = -0.12
        b = 0.03
        c = 1.07
        d = 0.24
        x = -0.7
    Else
        a = -0.4
        b = 0.1
        c = 3.5
        d = 0.8
        x = -0.7
    End If
End Select
Case "B"

Select Case CrossSlope
Case 2
    If Metric Then
        a = 0.3
        b = 0#
        c = 0.98
        d = 0.52
        x = -0.5
    Else
        a = 1#
        b = 0#
        c = 3.2
        d = 1.7
        x = -0.5
    End If
Case 4
    If Metric Then
        a = 0.46
        b = 0.15
        c = 0.79
        d = 0.58
        x = -0.5
    Else
        a = 1.5
        b = 0.5

```

```

        c = 2.6
        d = 1.9
        x = -0.5
    End If
Case Else
    strAlert = strAlert & "Cross slope must be either 2% or 4%," &
-
        "other cross slopes were not modelled. Assuming 2%."
"
    a = 1#
    b = 0#
    c = 3.2
    d = 1.7
    x = -0.5
End Select
End Select
Qo = (a + (b * Length)) * (slope) ^ x
Qa = (c + (d * Length)) * (slope) ^ x
If Qt <= Qo Then
    InletIntercept = Qt
Else
    InletIntercept = Qo + (Qa - Qo) * (1 - Exp(-((Qt - Qo) / (Qa -
Qo))))
End If
End If
If strAlert <> "" Then MsgBox strAlert, vbExclamation
End Function

```